

Chassis for Formula 1 Car

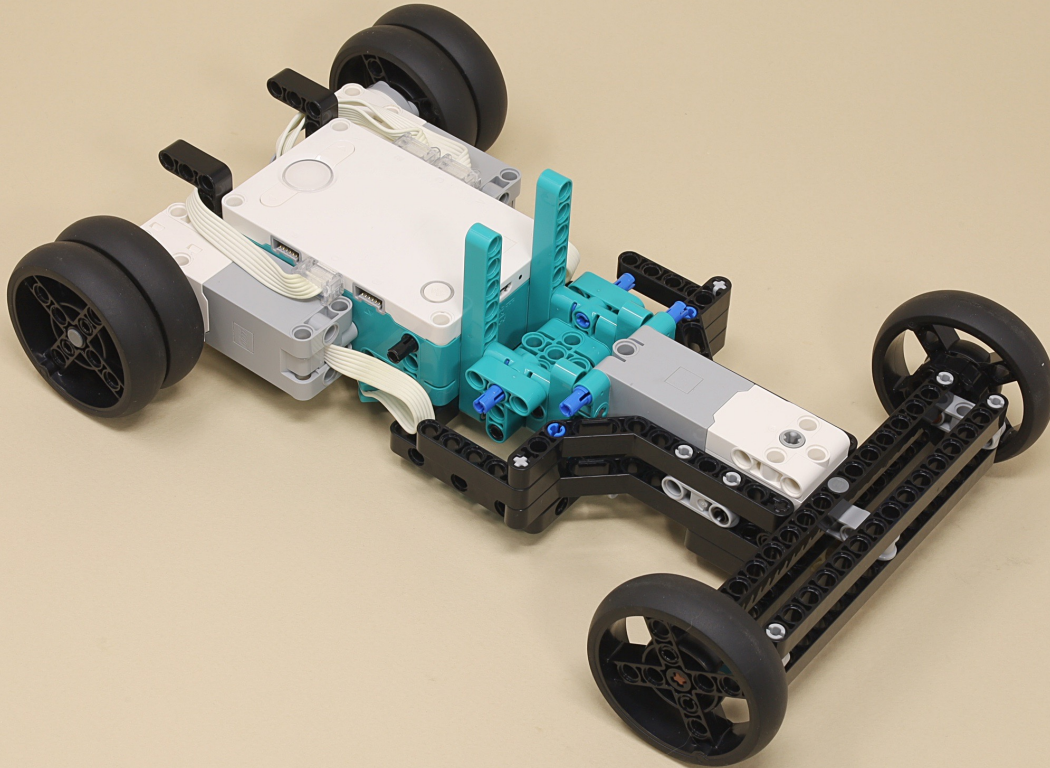

Scroll for
building
instructions

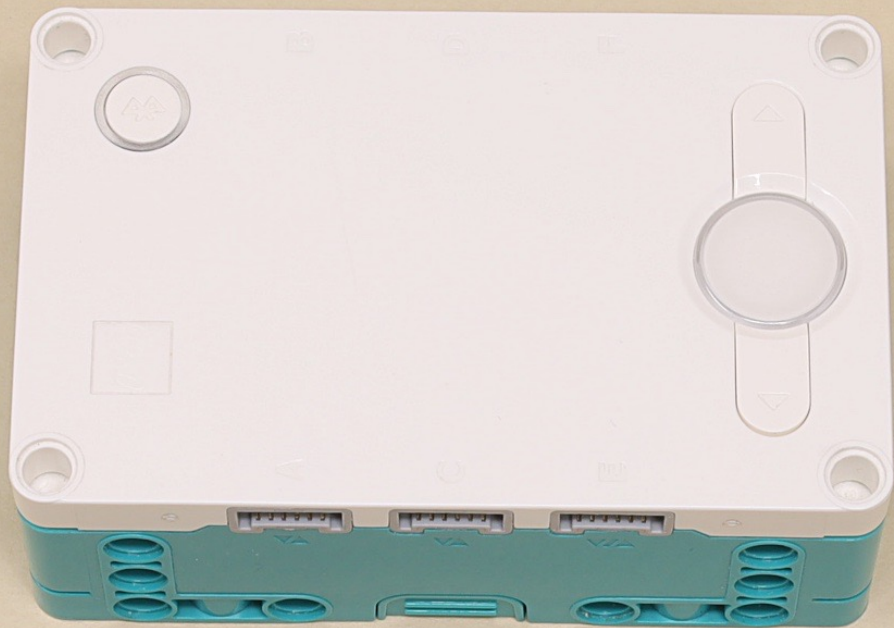



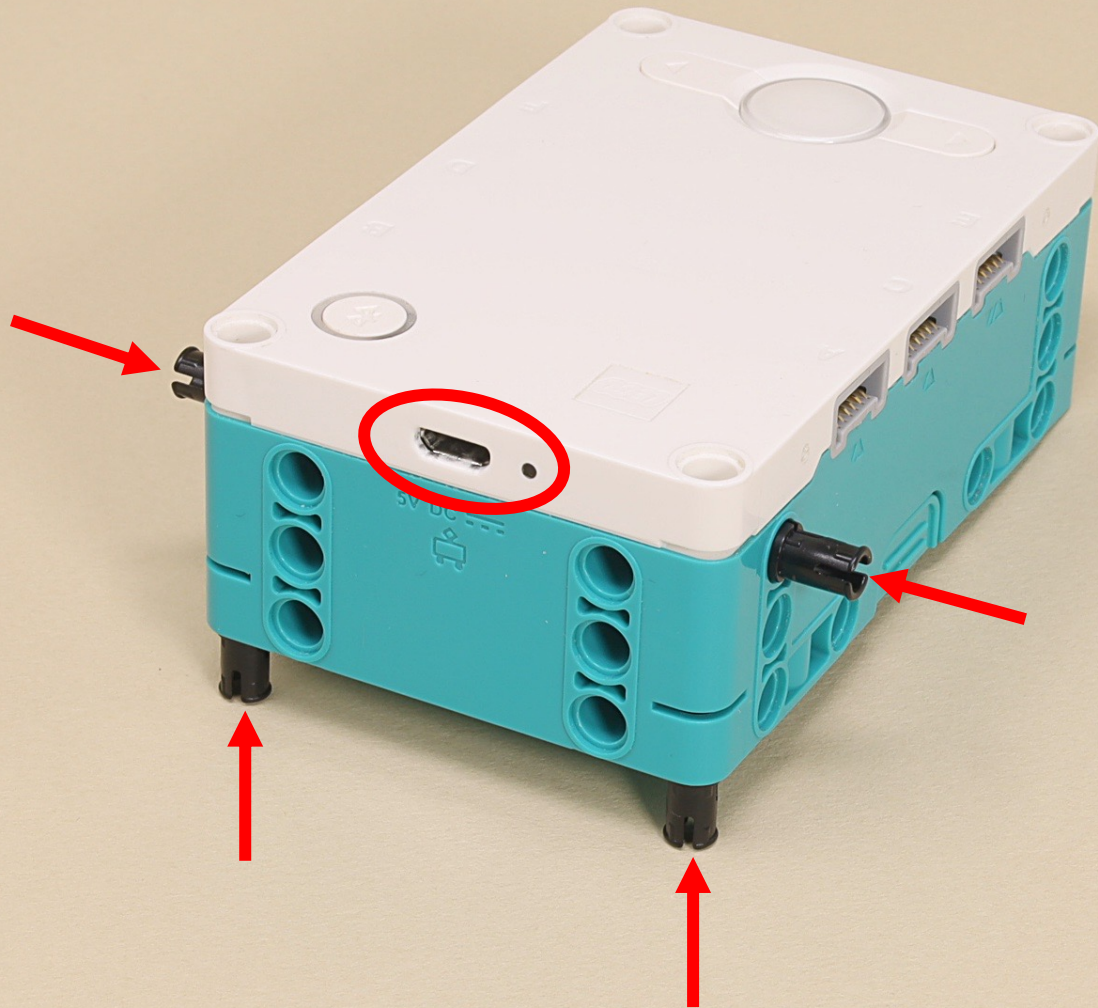

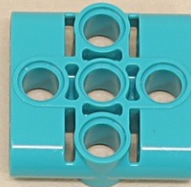
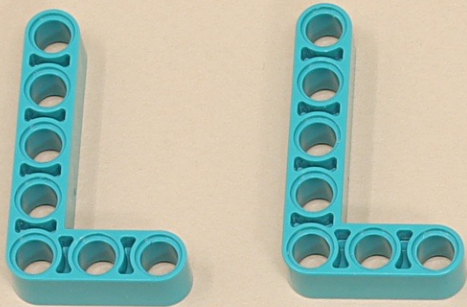

9



9



(8 x)



(6 x)



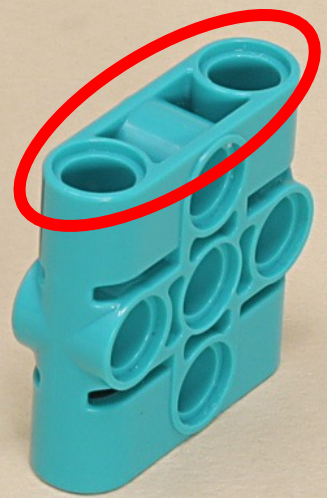
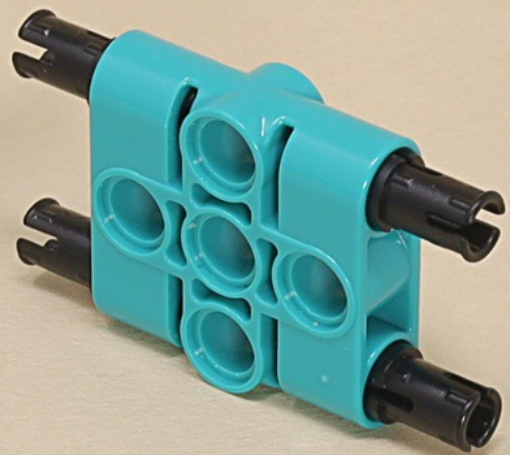

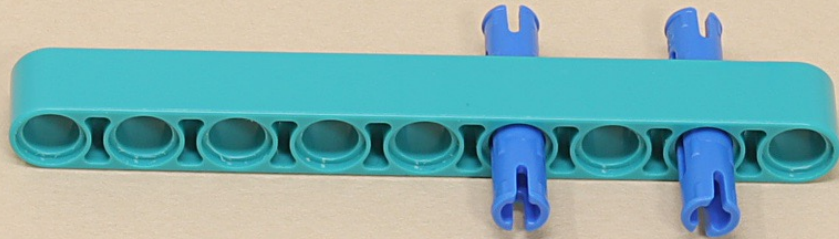
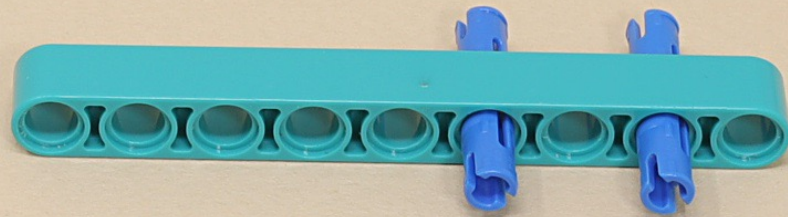
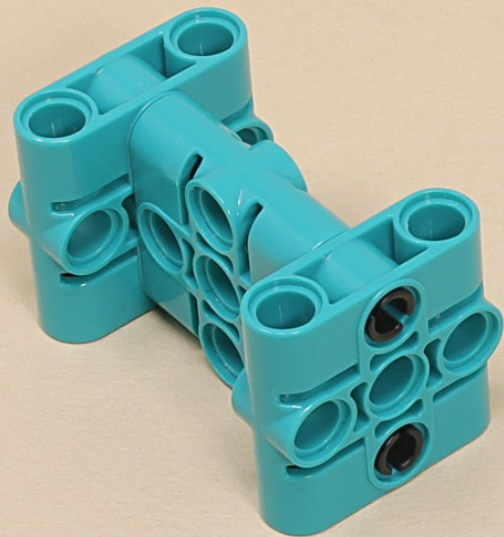

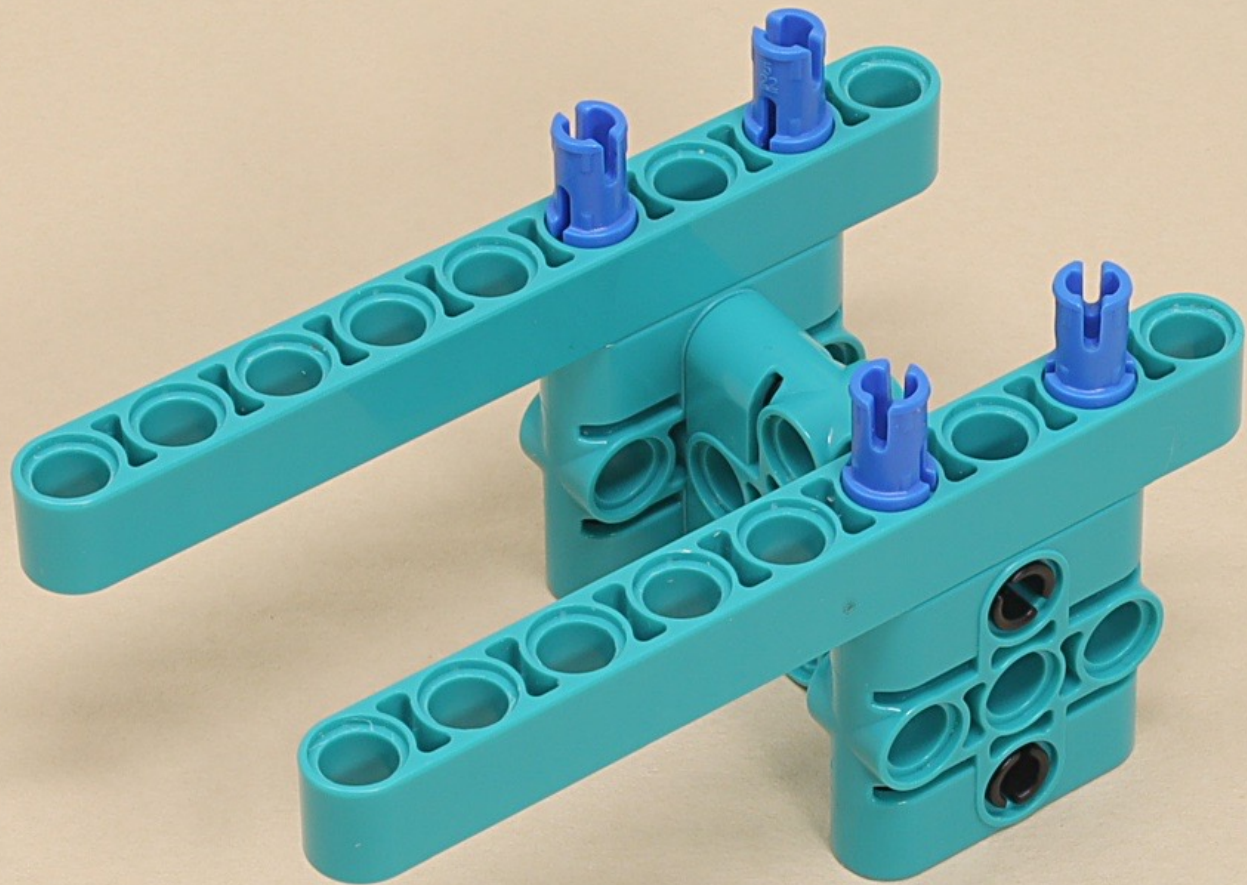



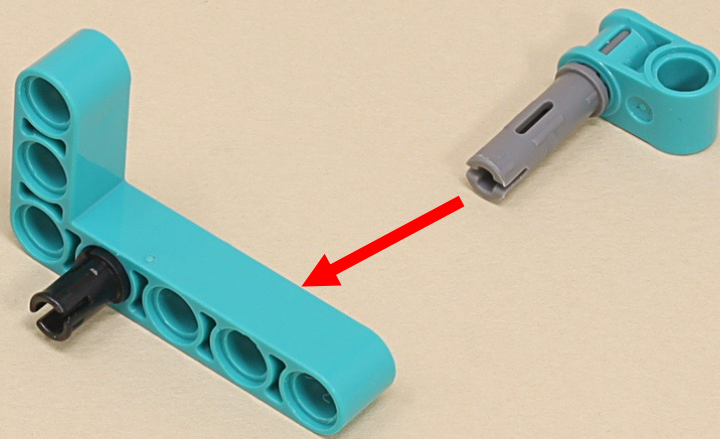
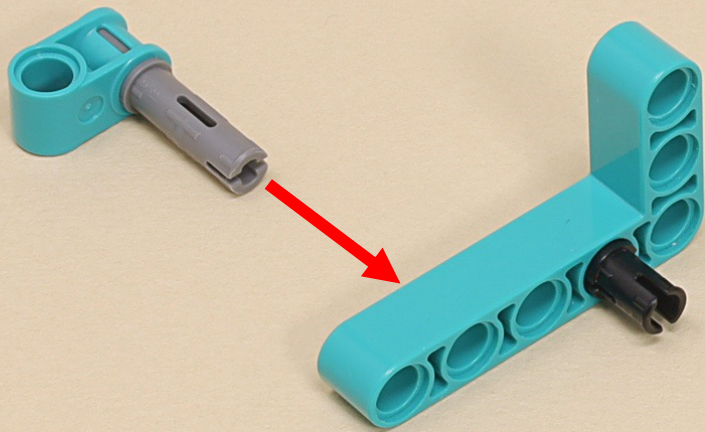

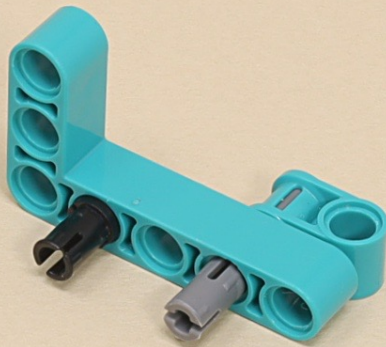
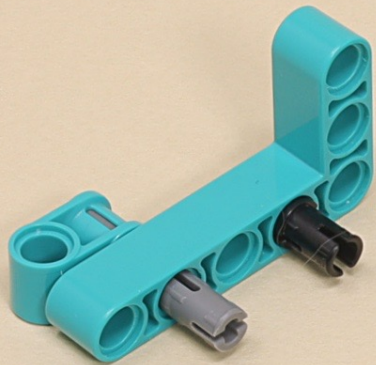

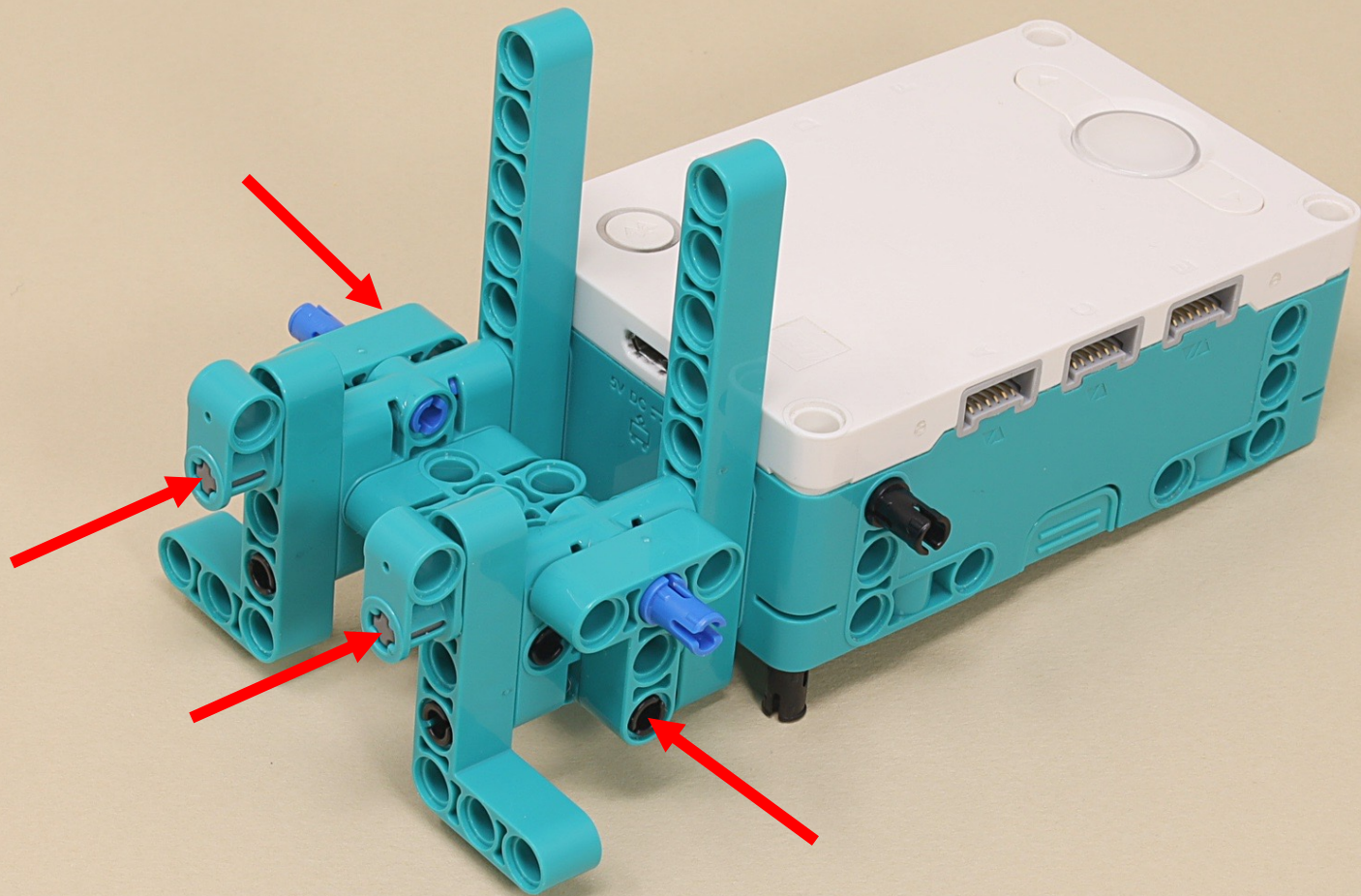

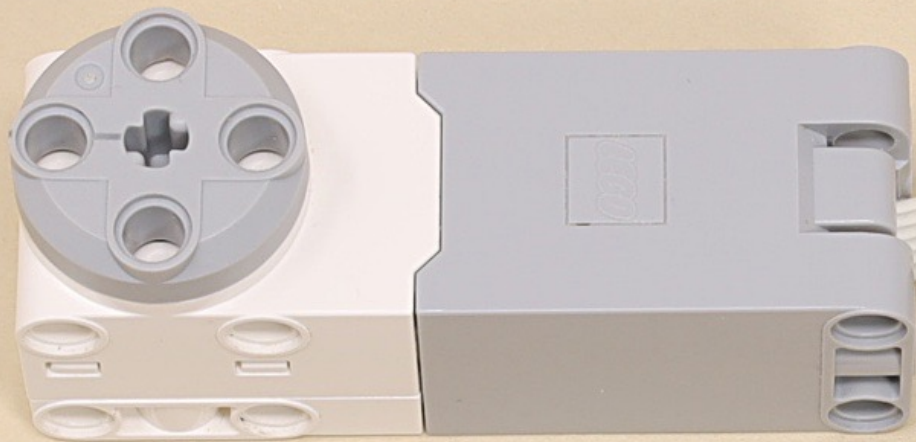

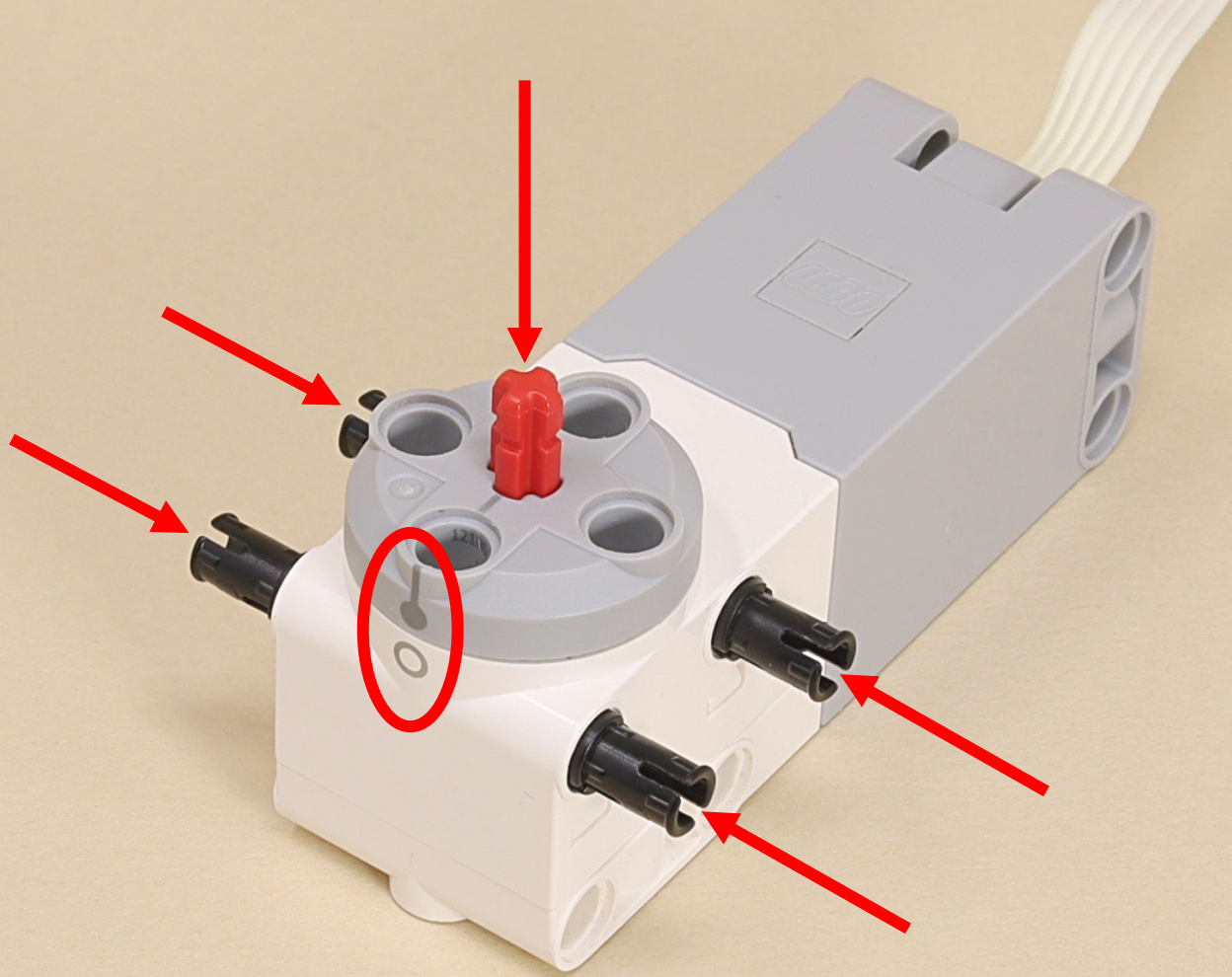

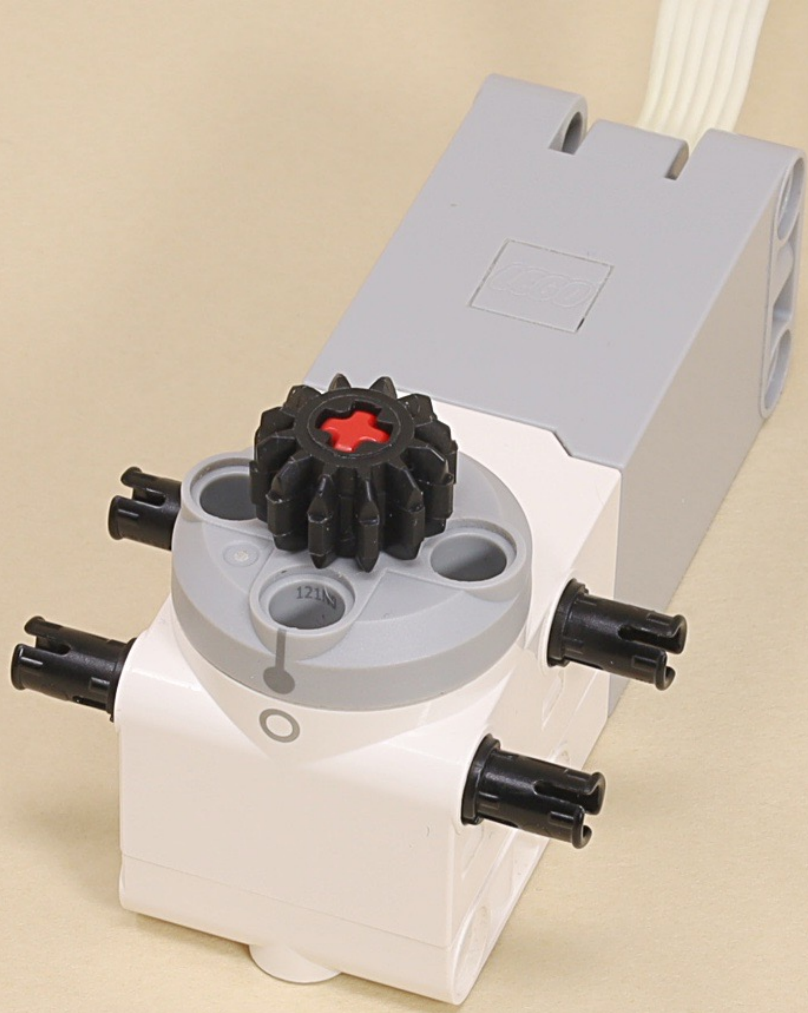

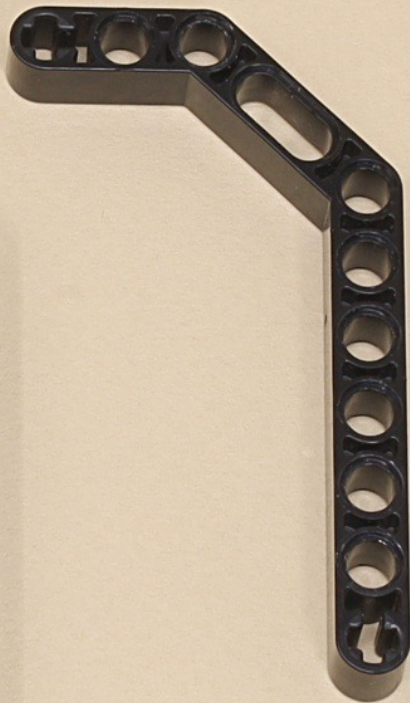
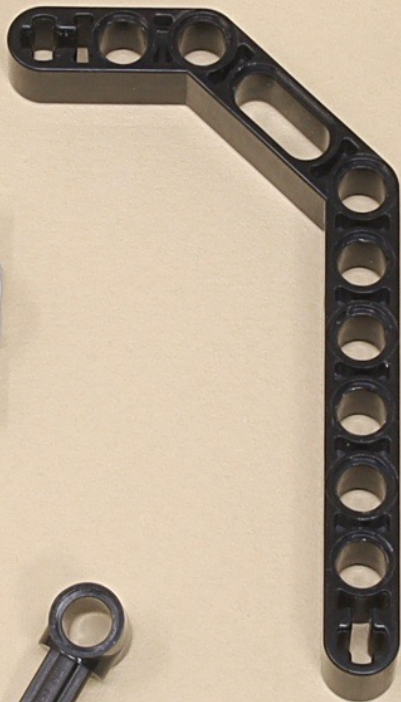
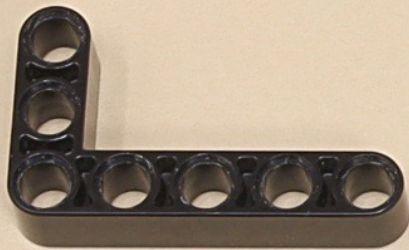

3



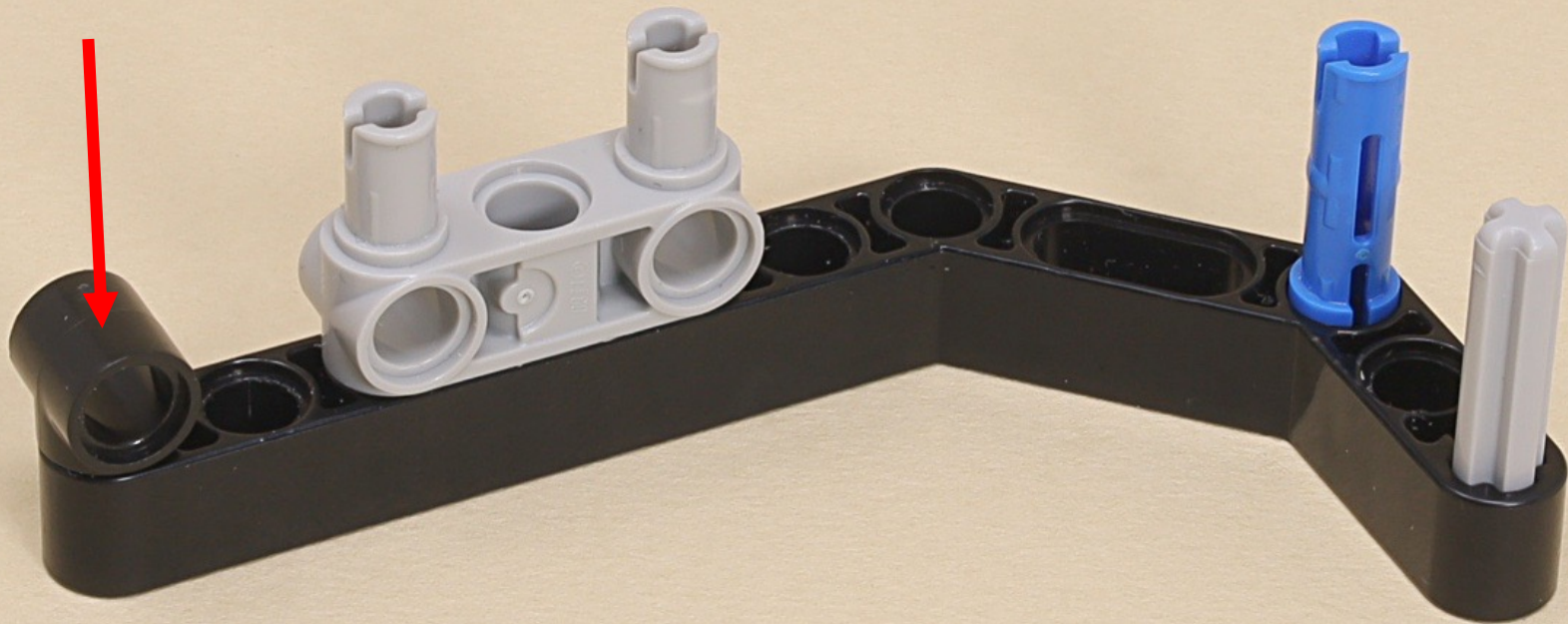

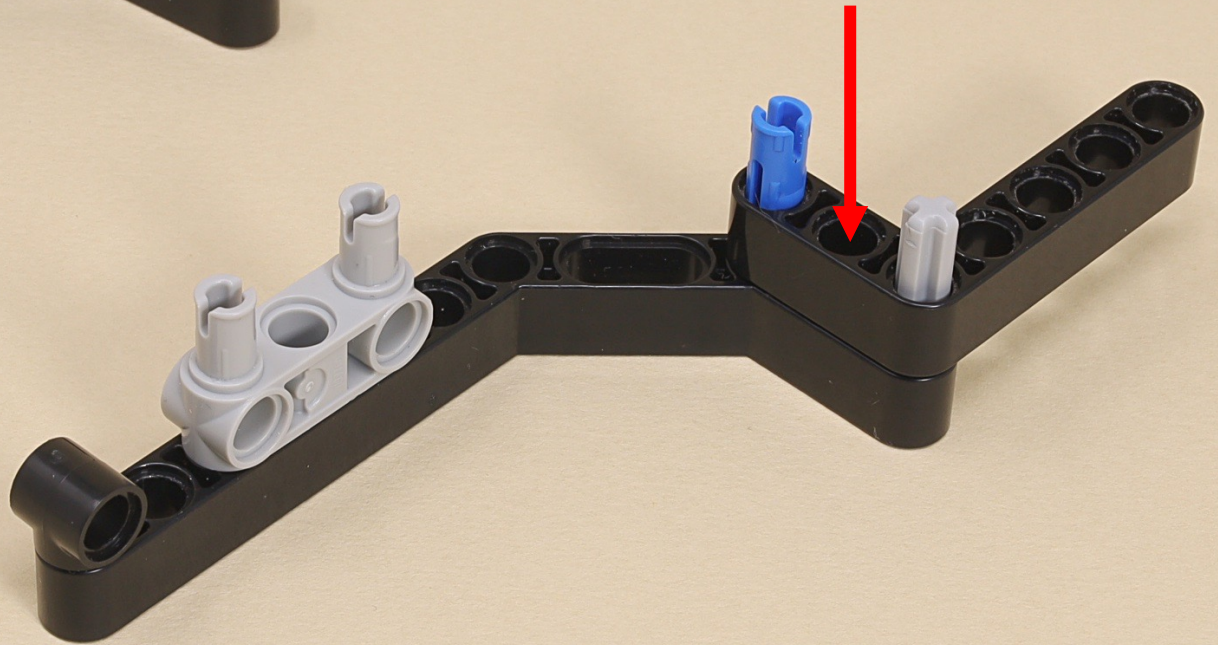
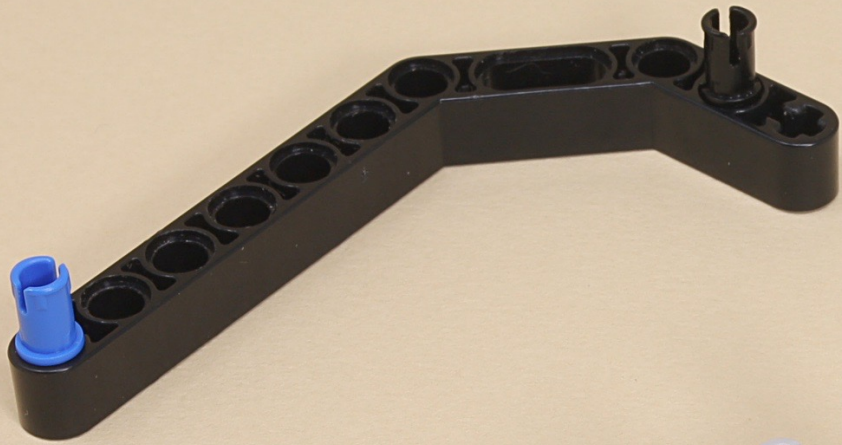

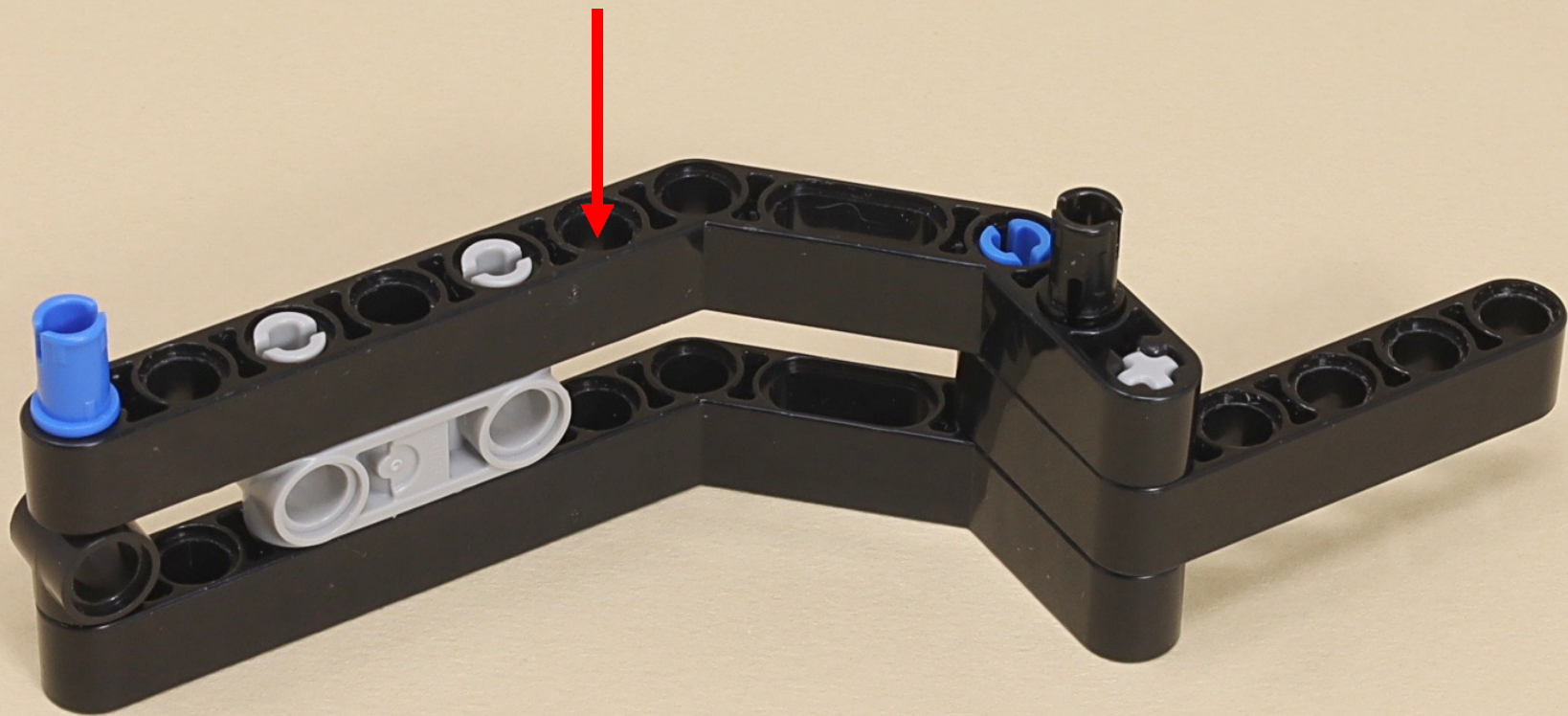

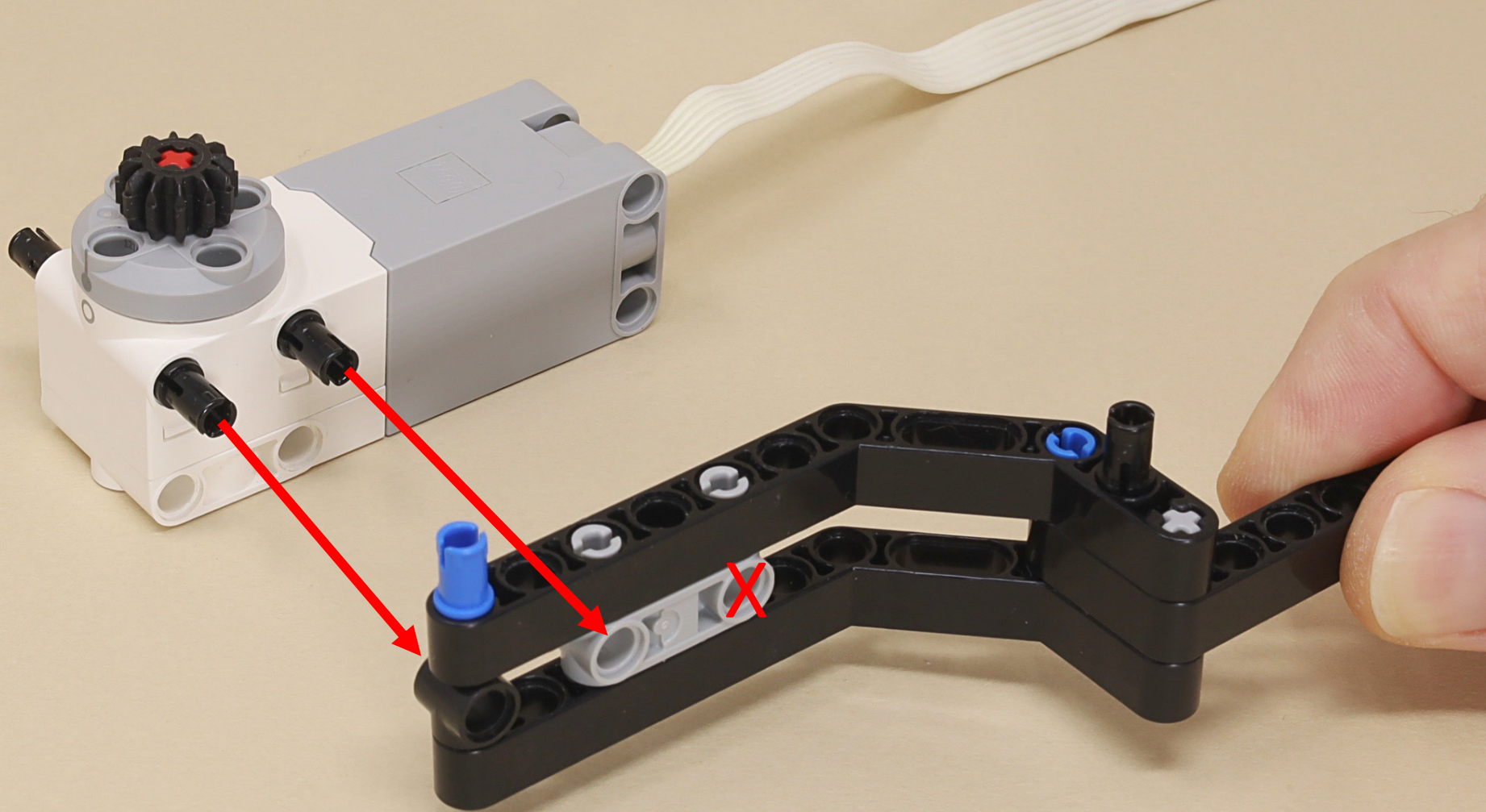

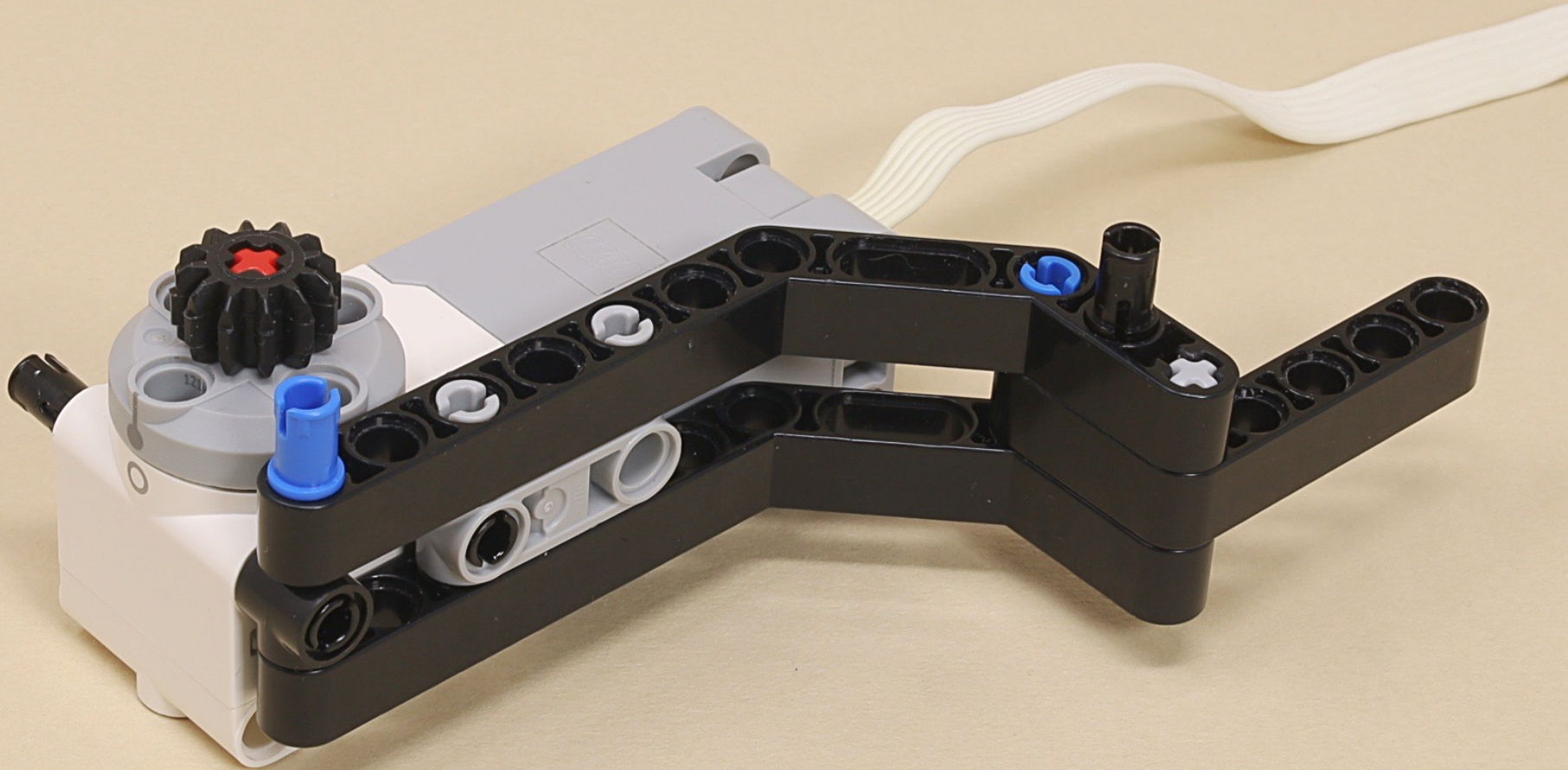

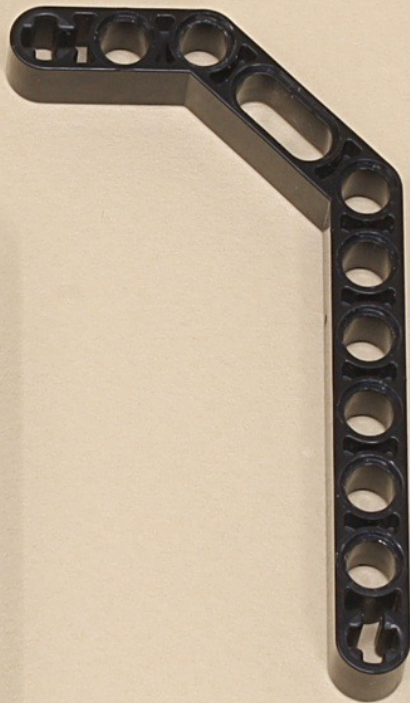
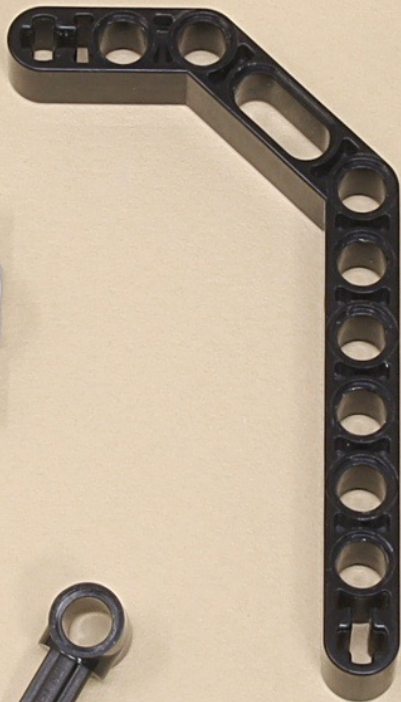

3



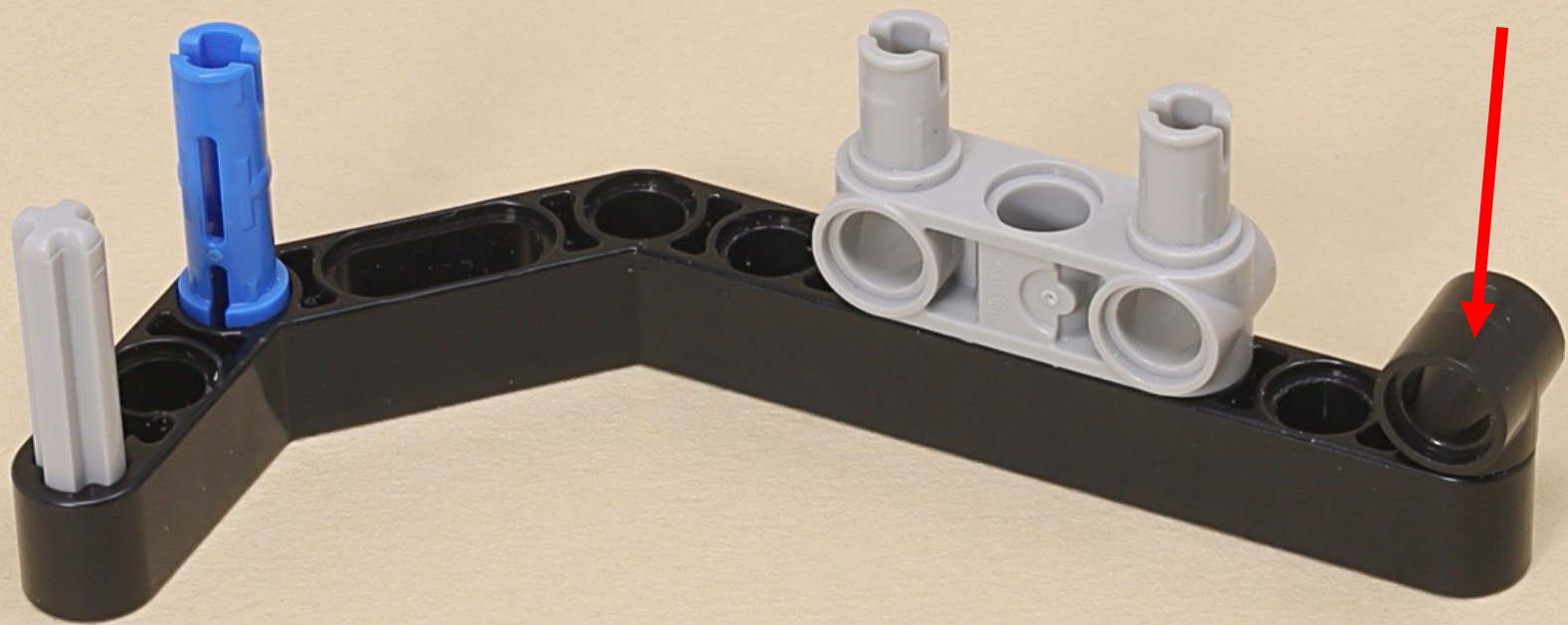



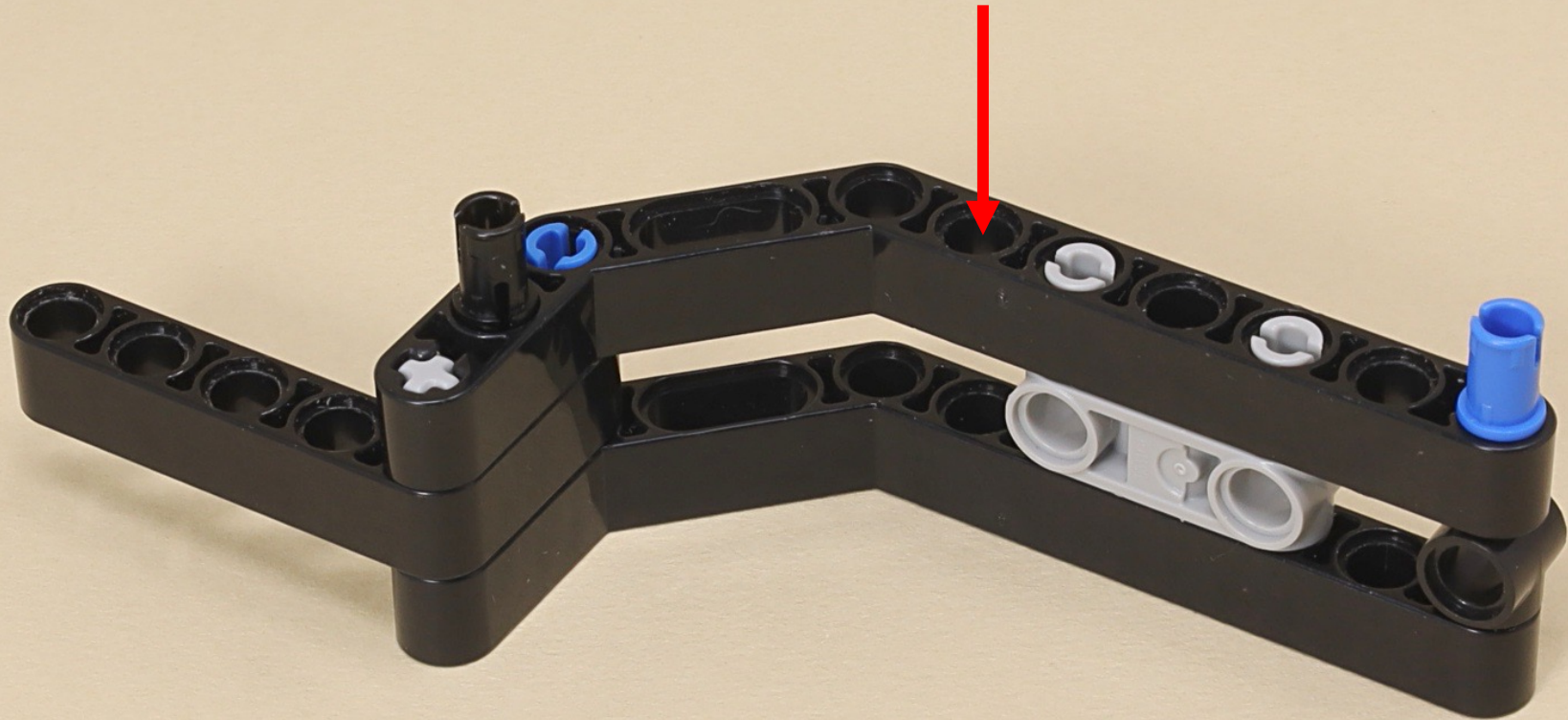

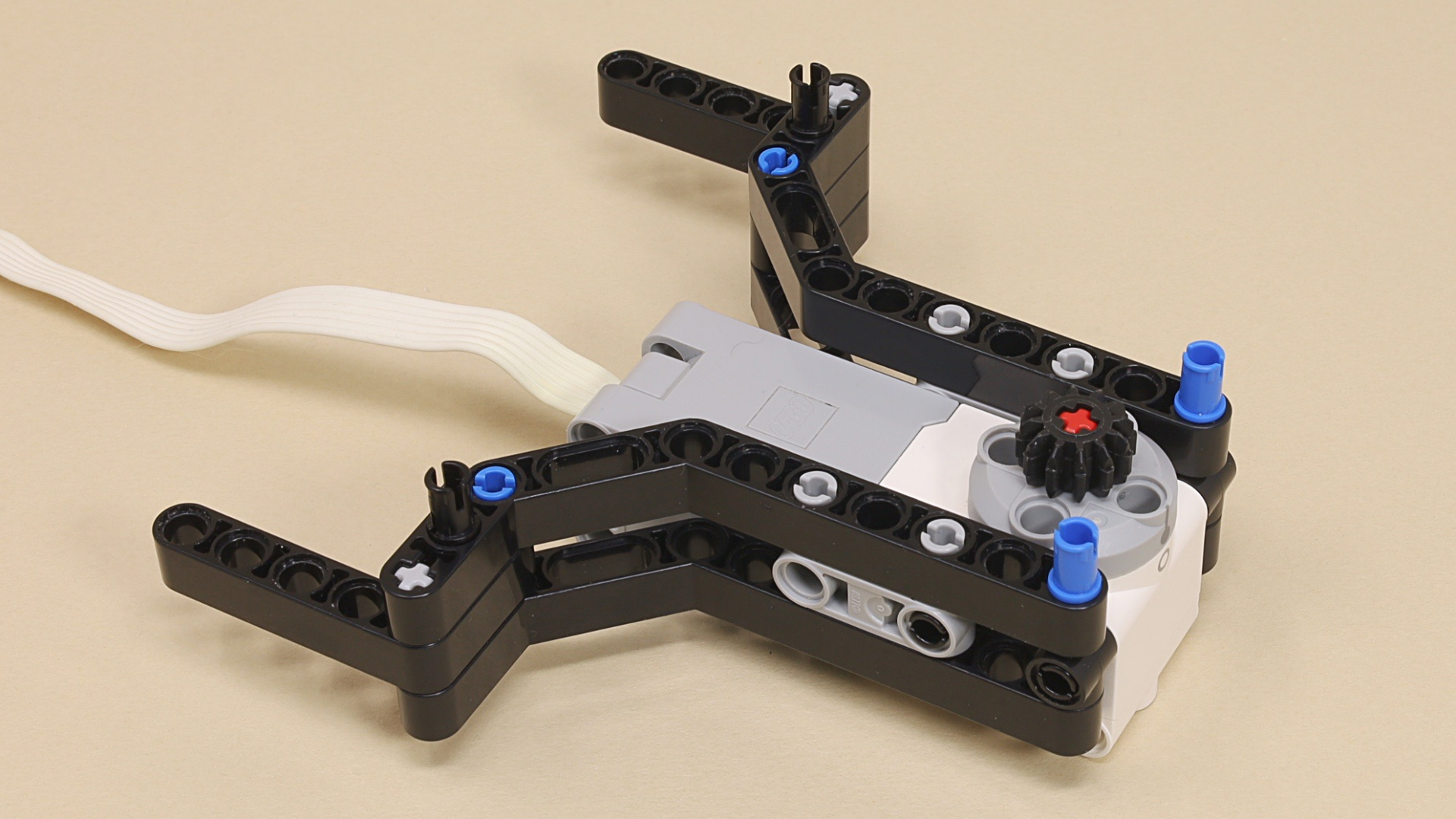

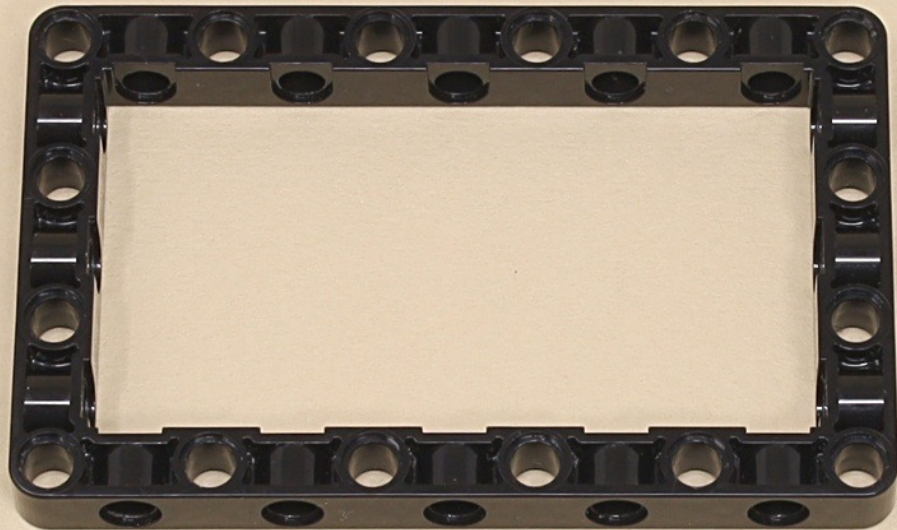

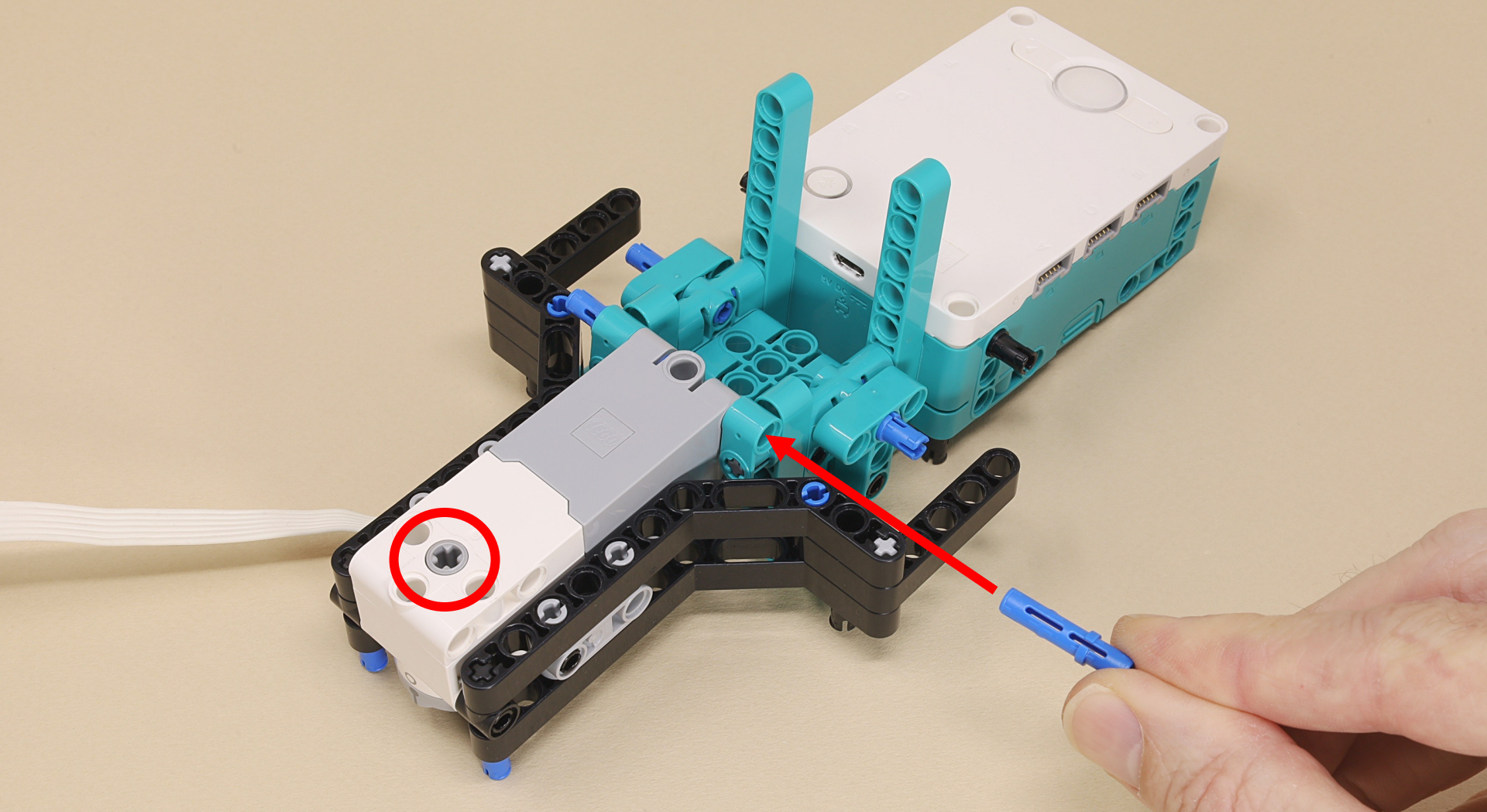

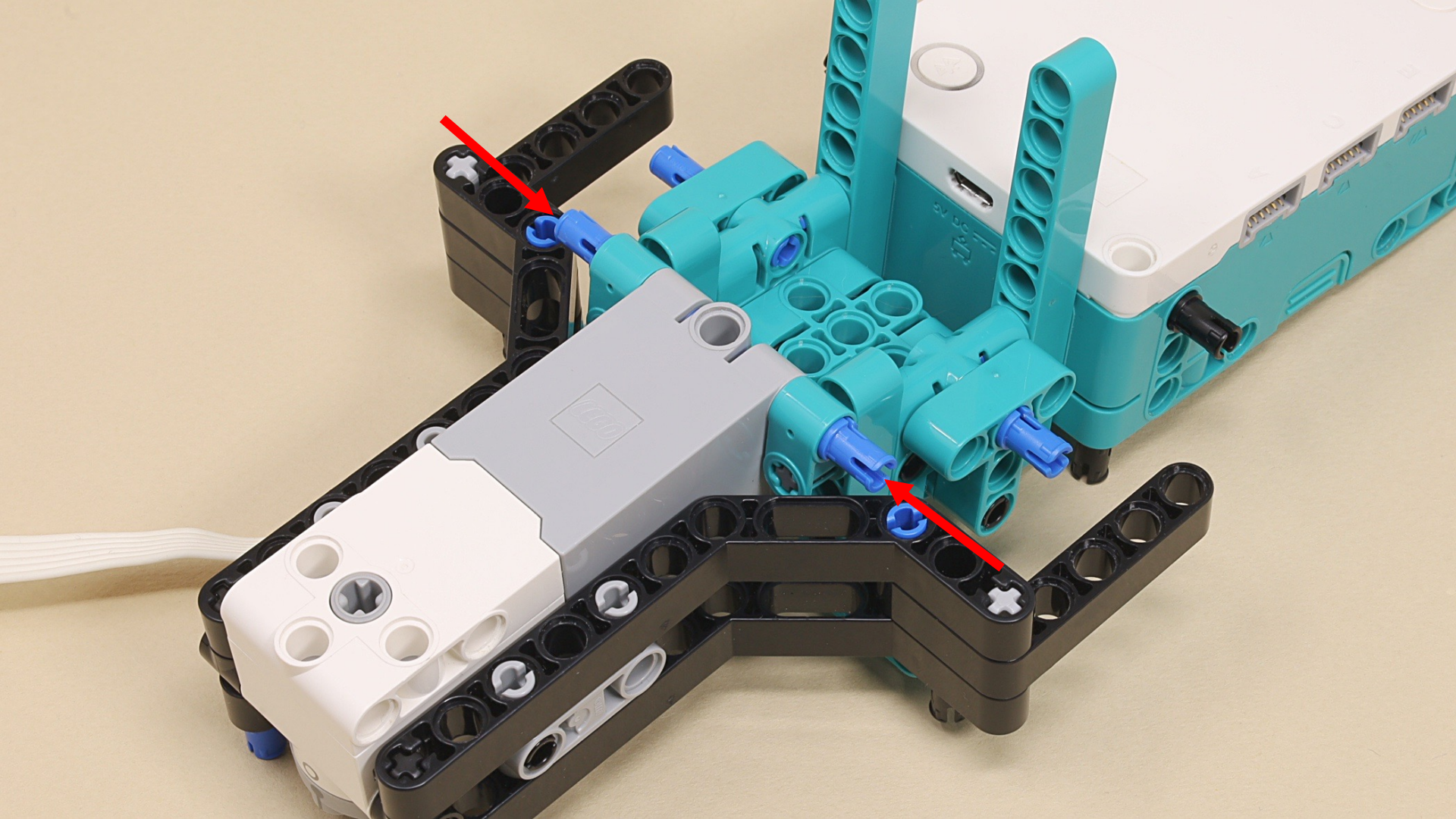

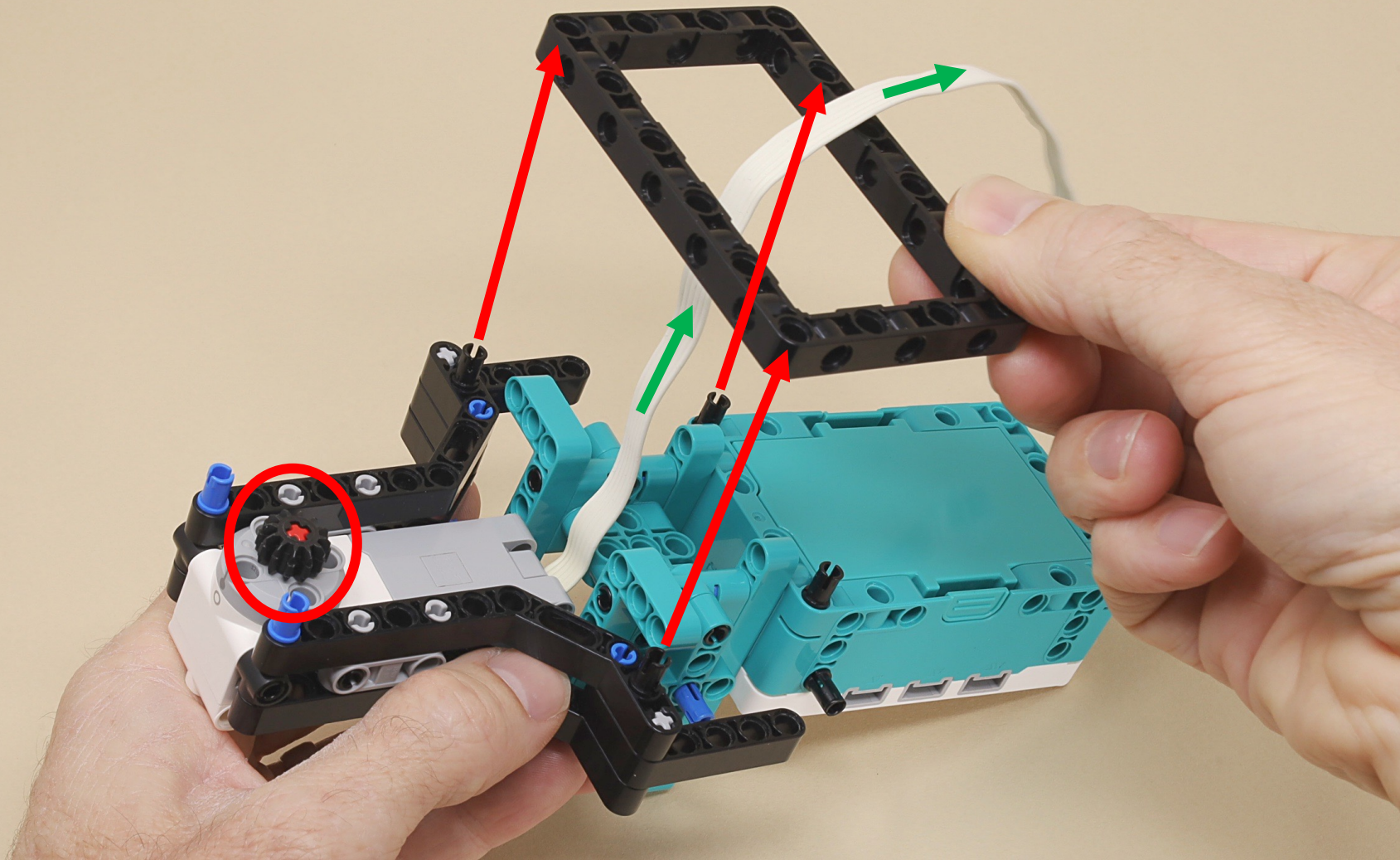

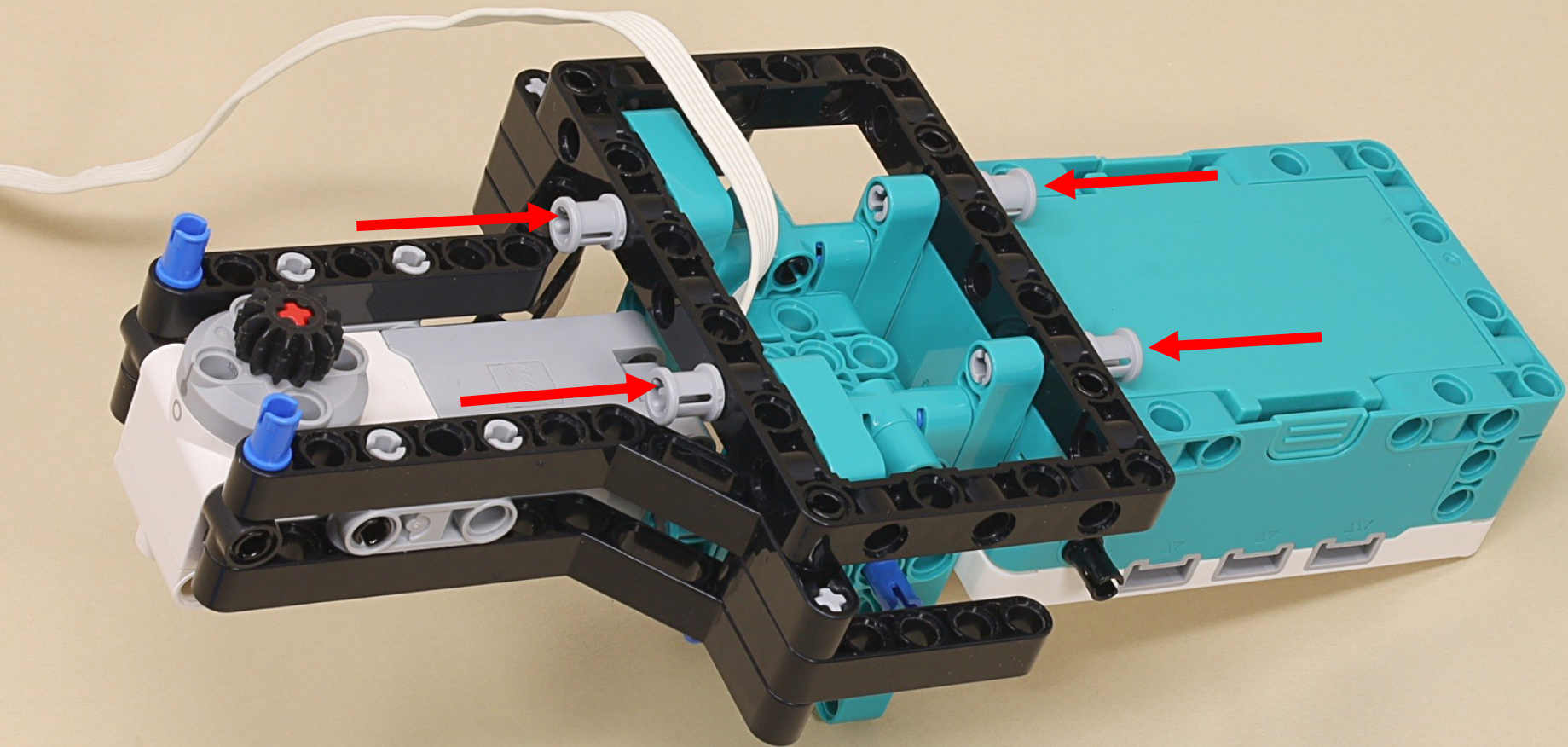

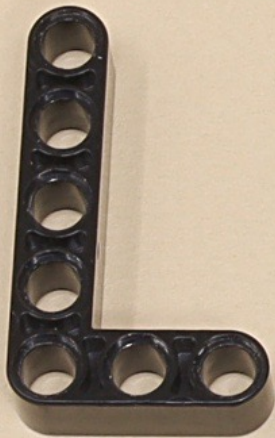



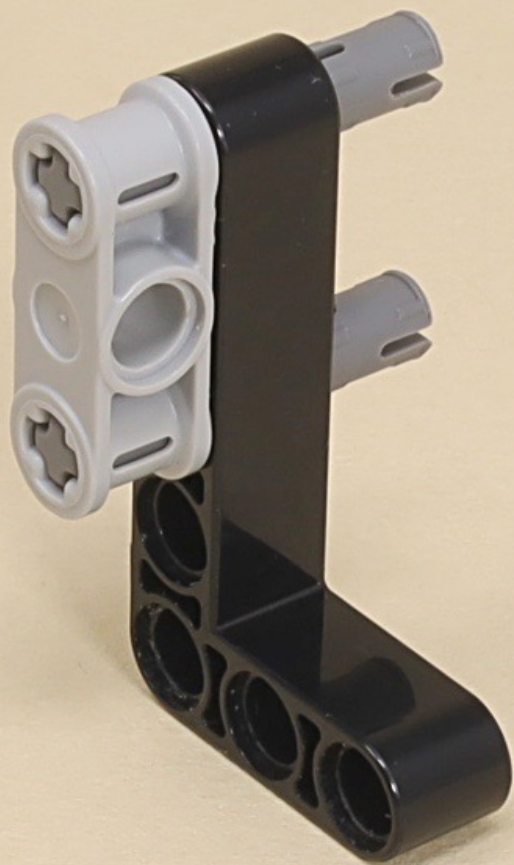

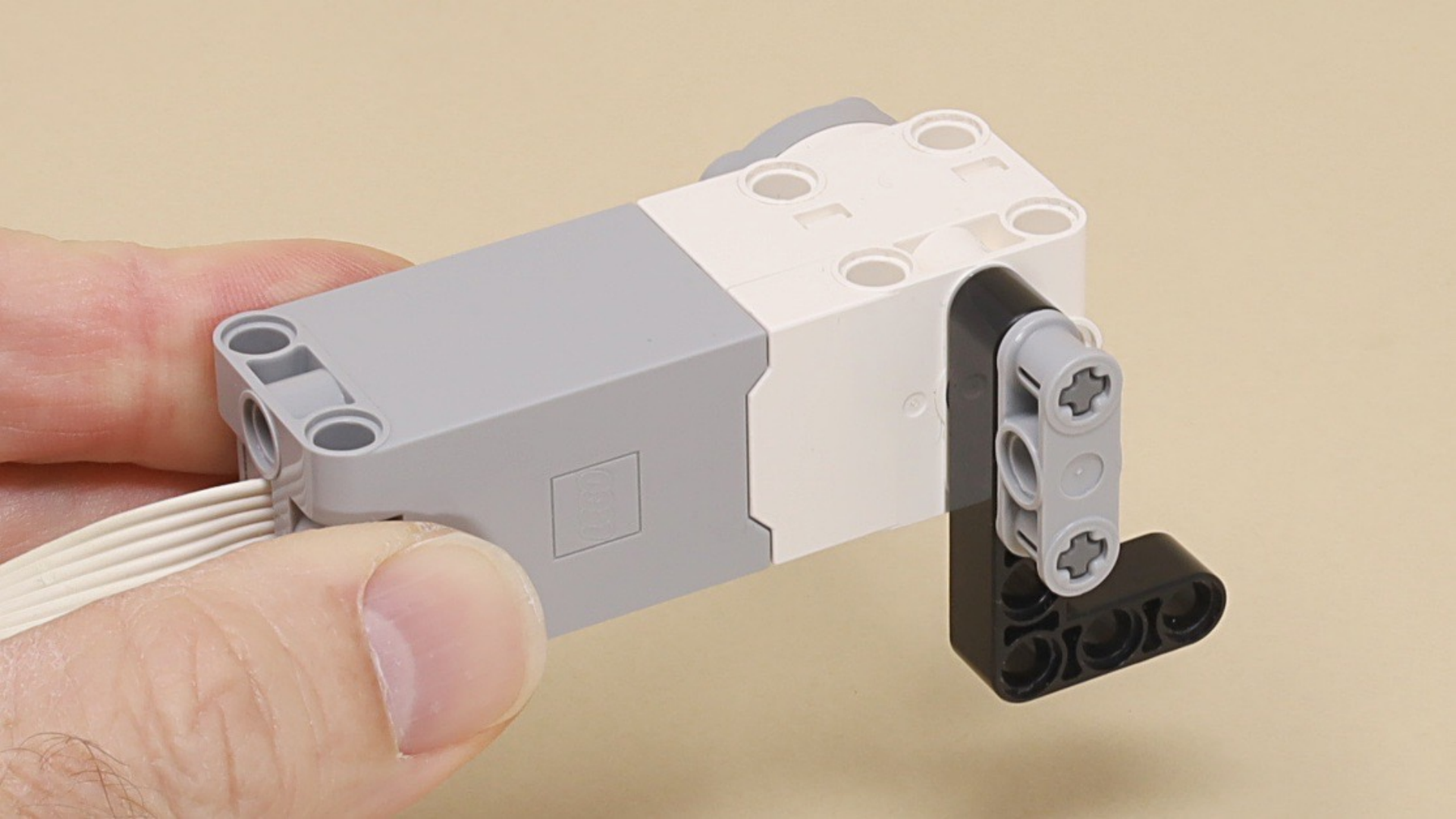





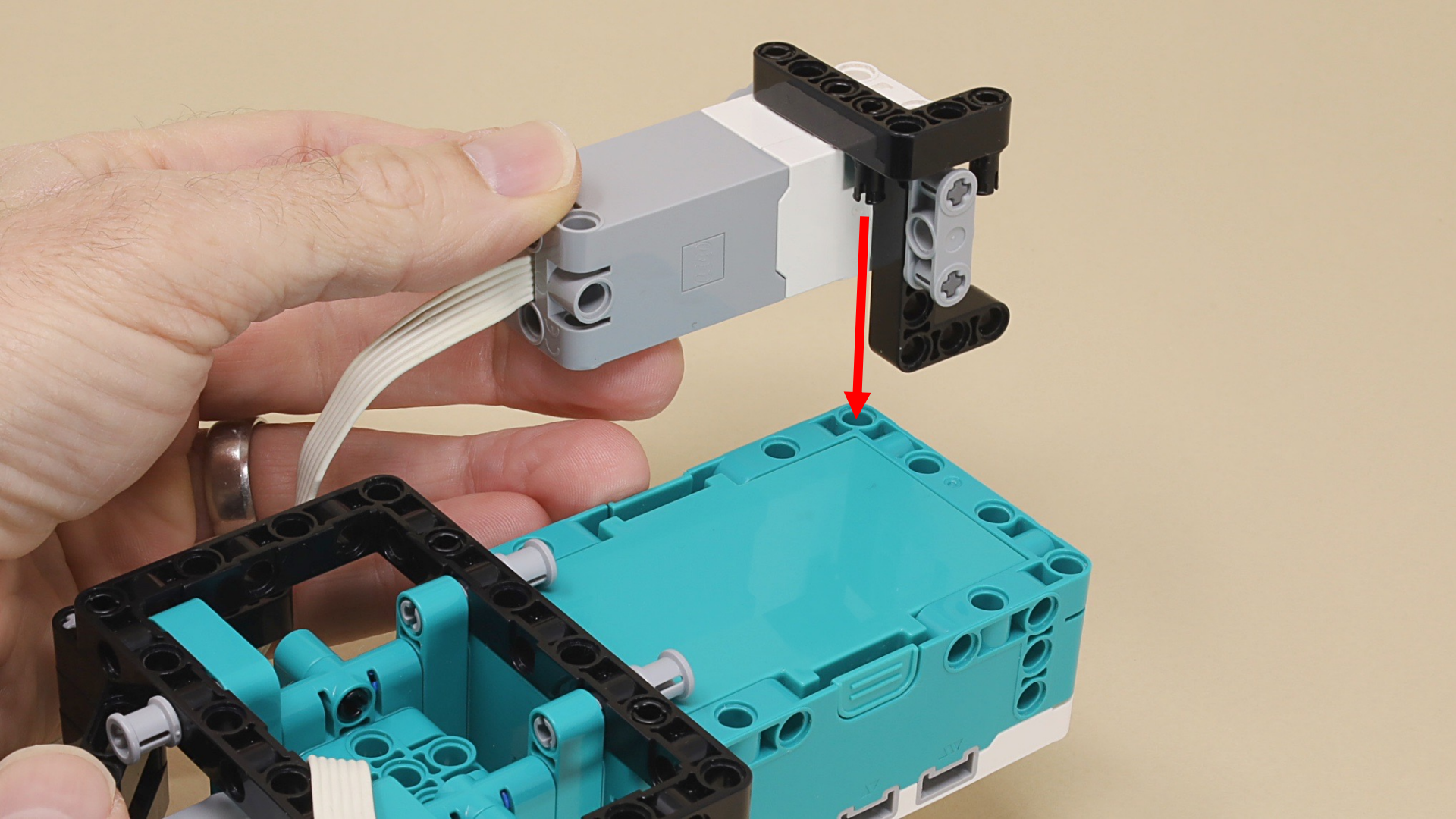





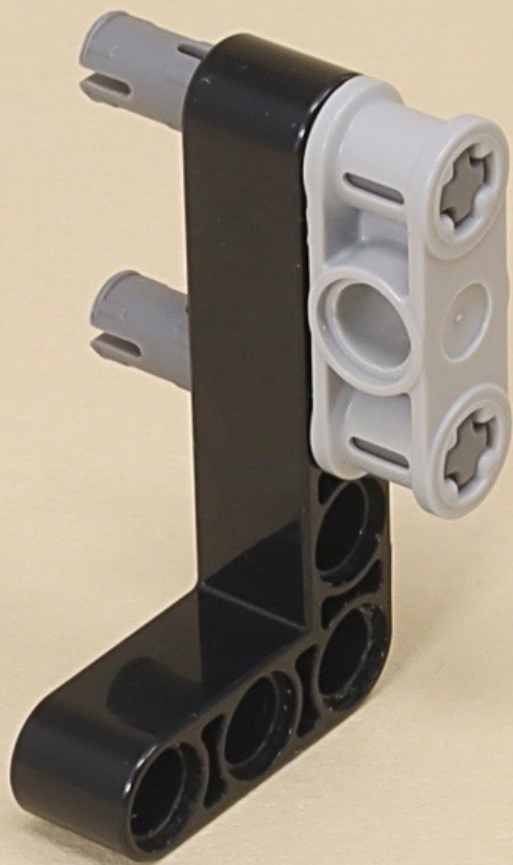

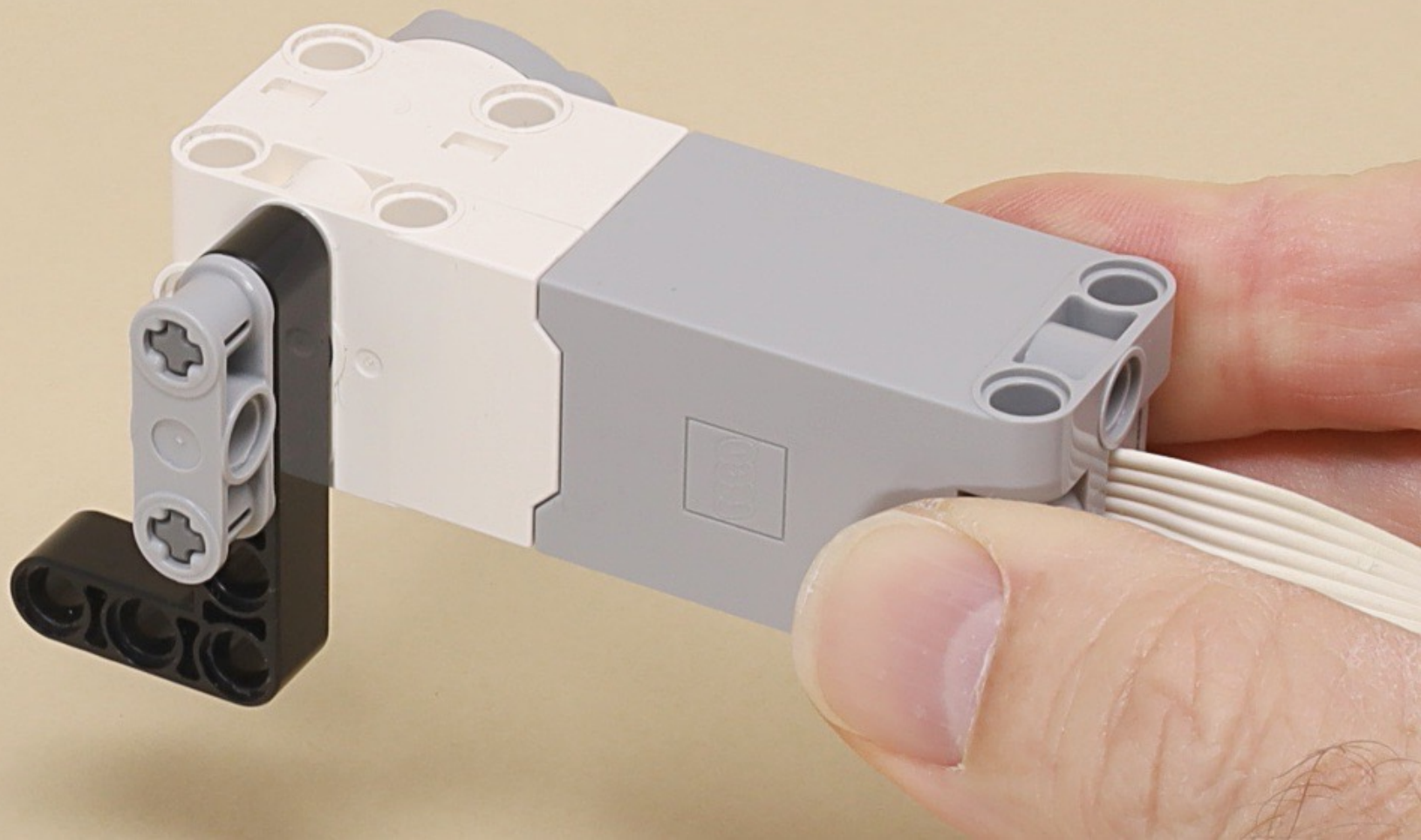





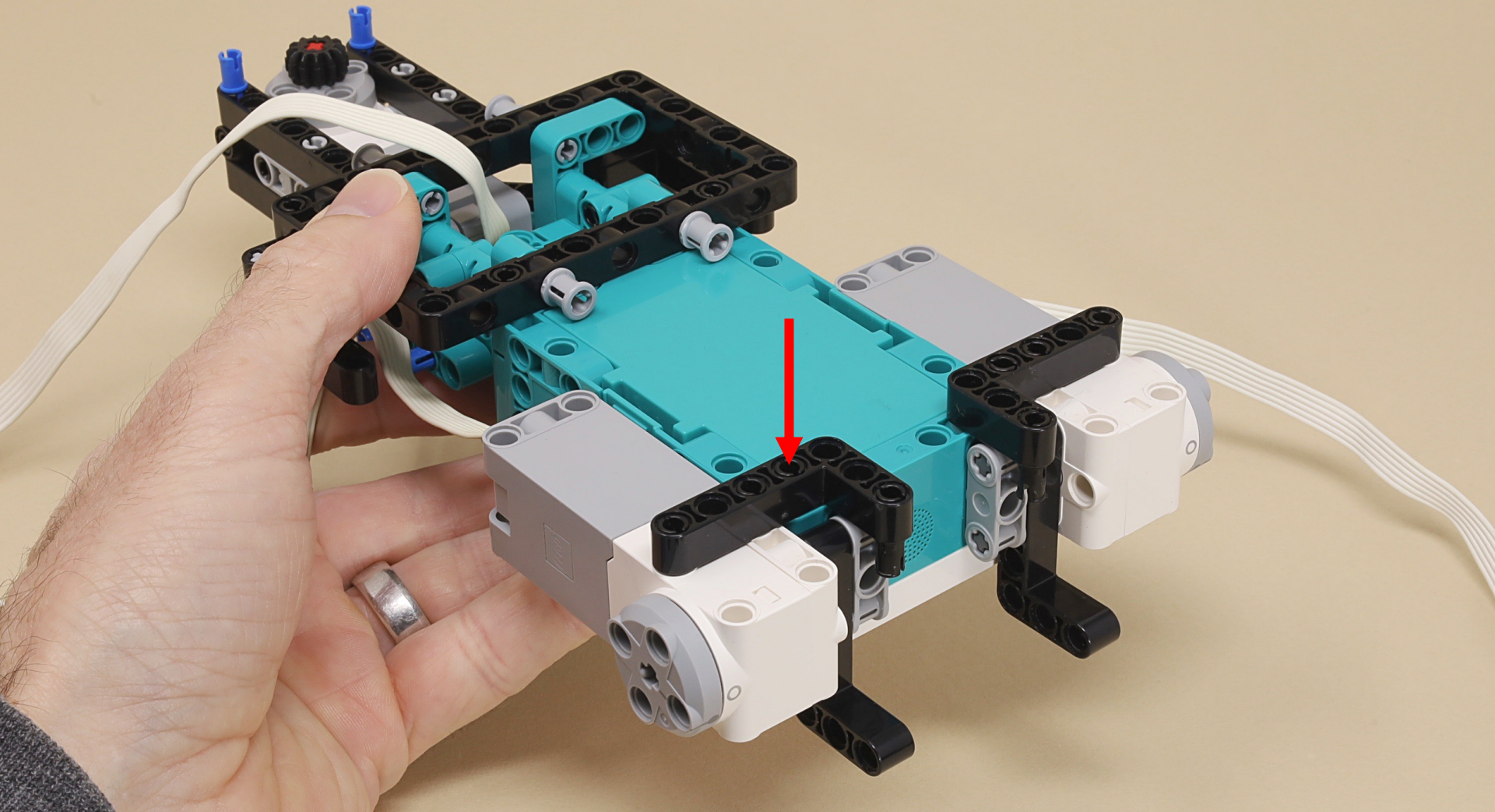

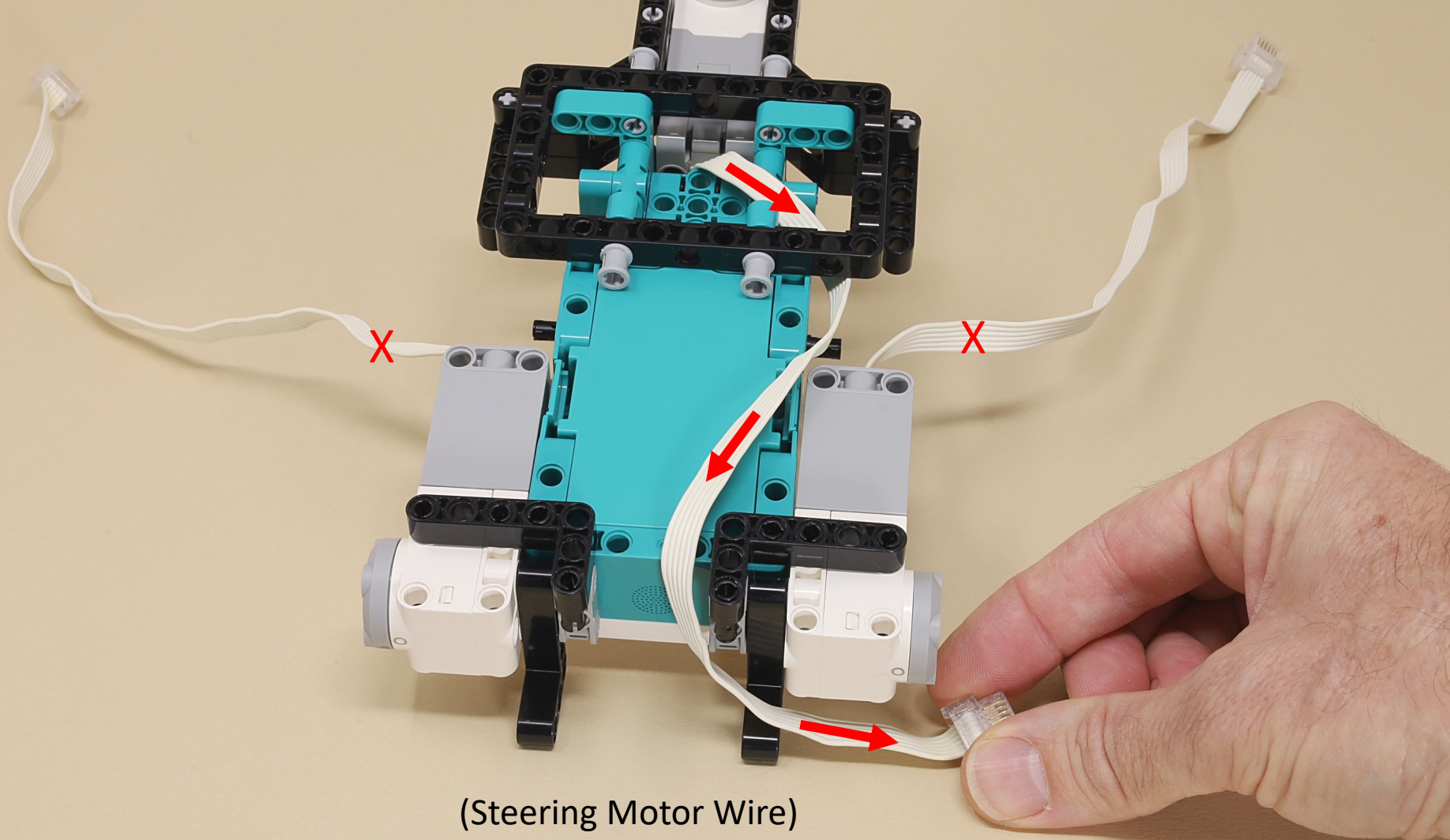

(Steering Motor Wire)

E = Steering Motor

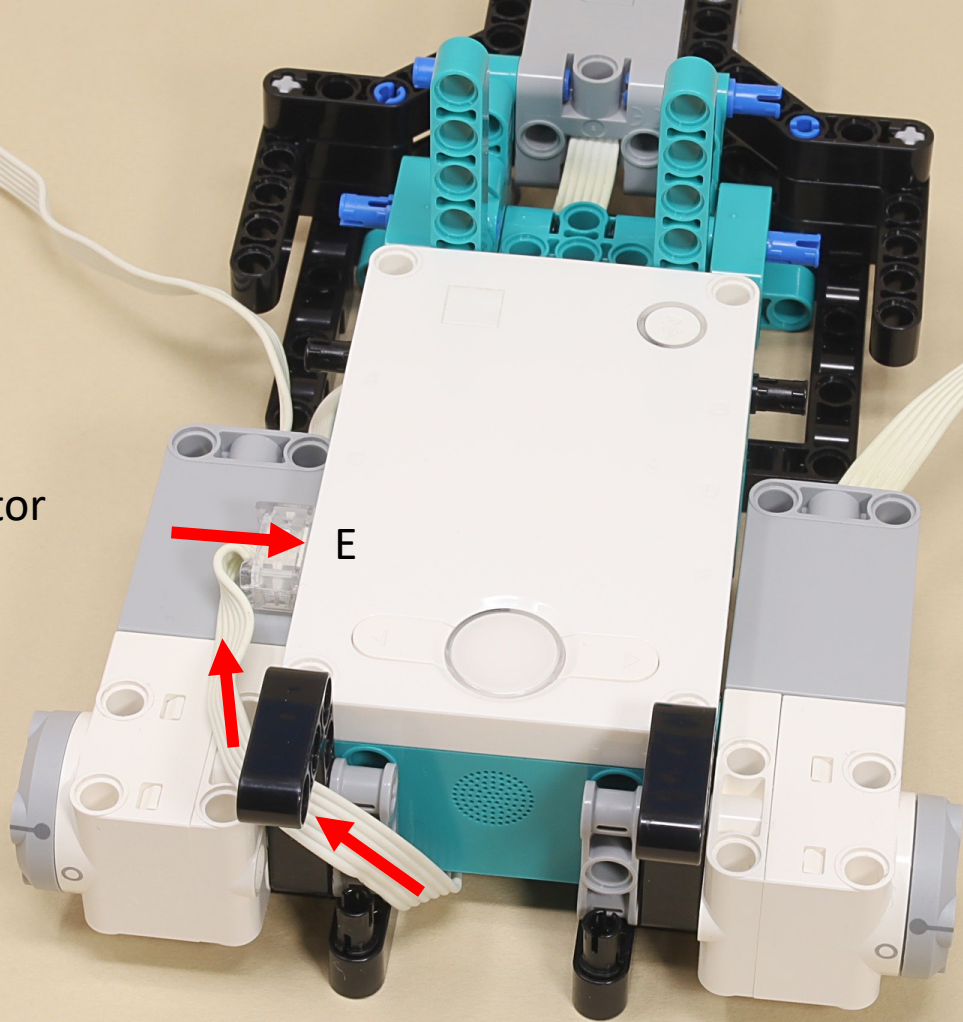



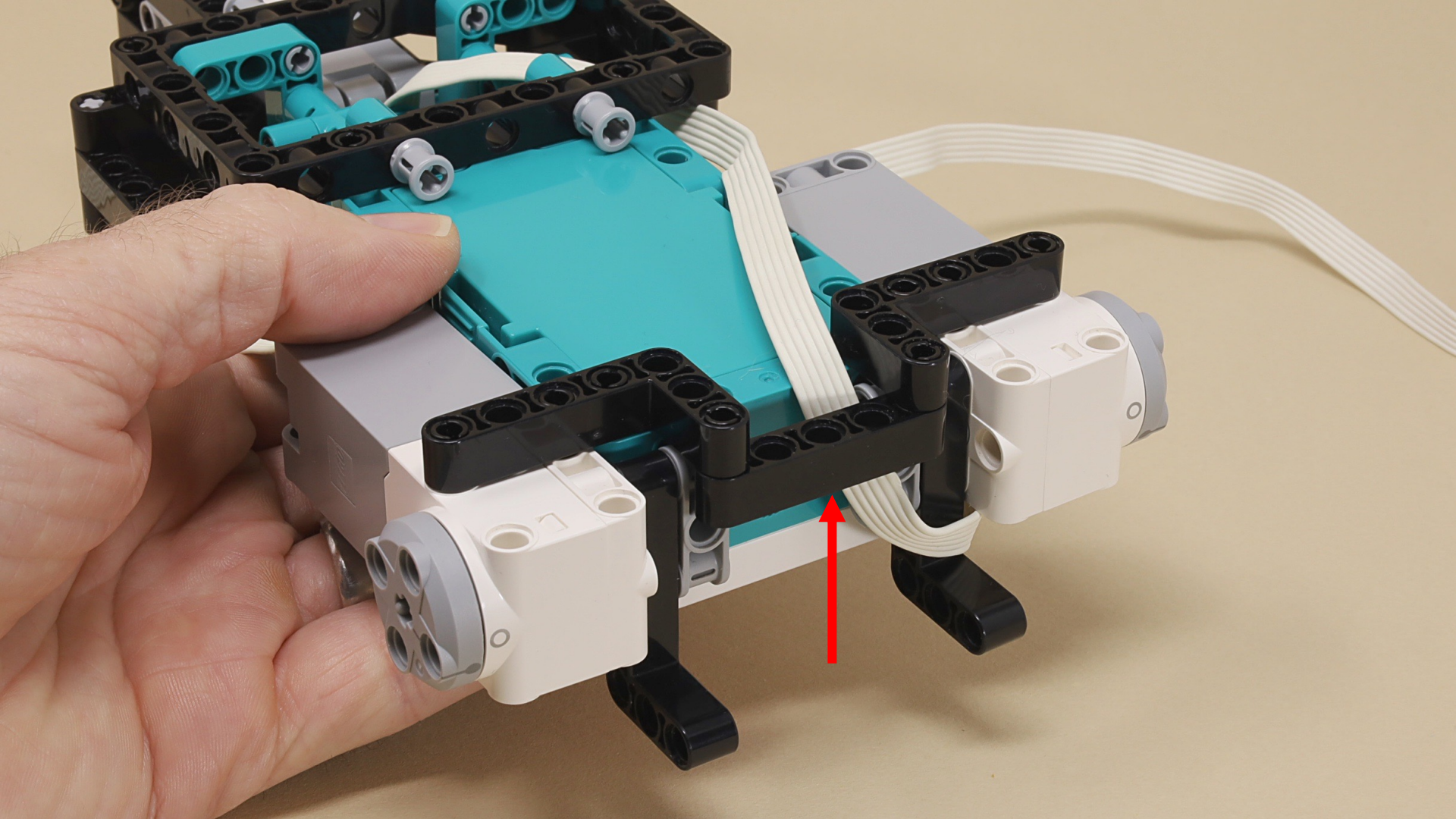

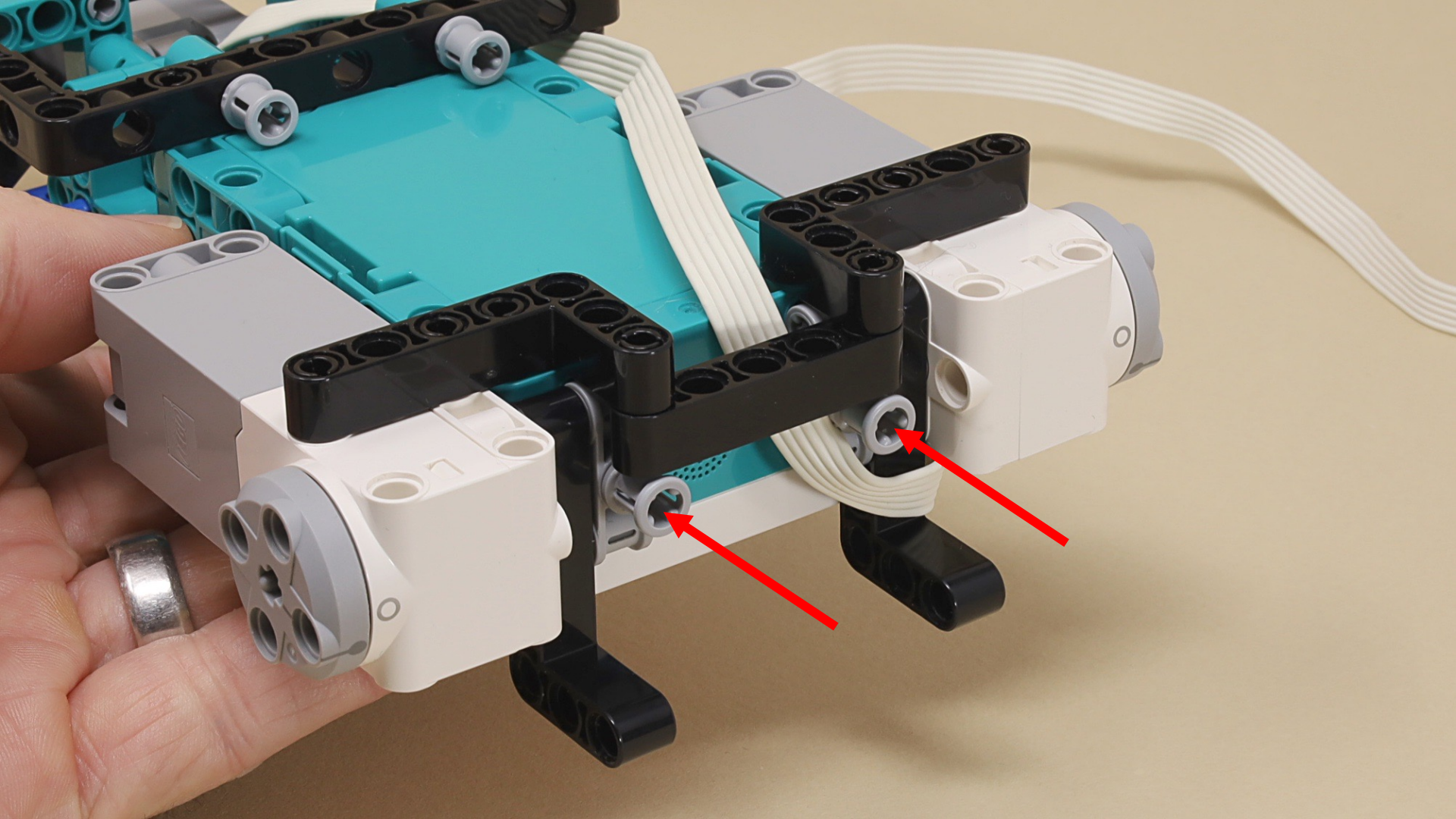

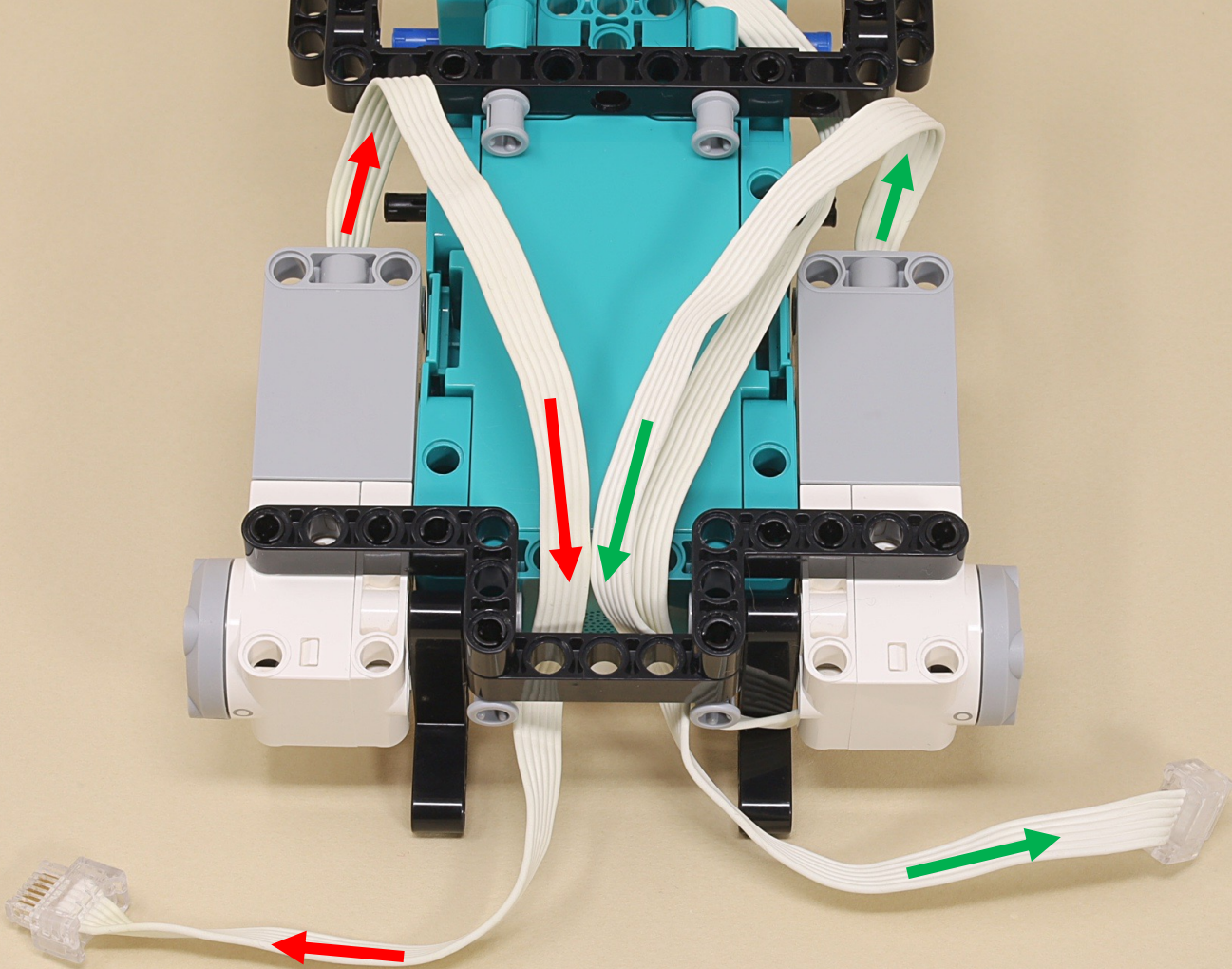

● C = Left Motor

● D = Right Motor

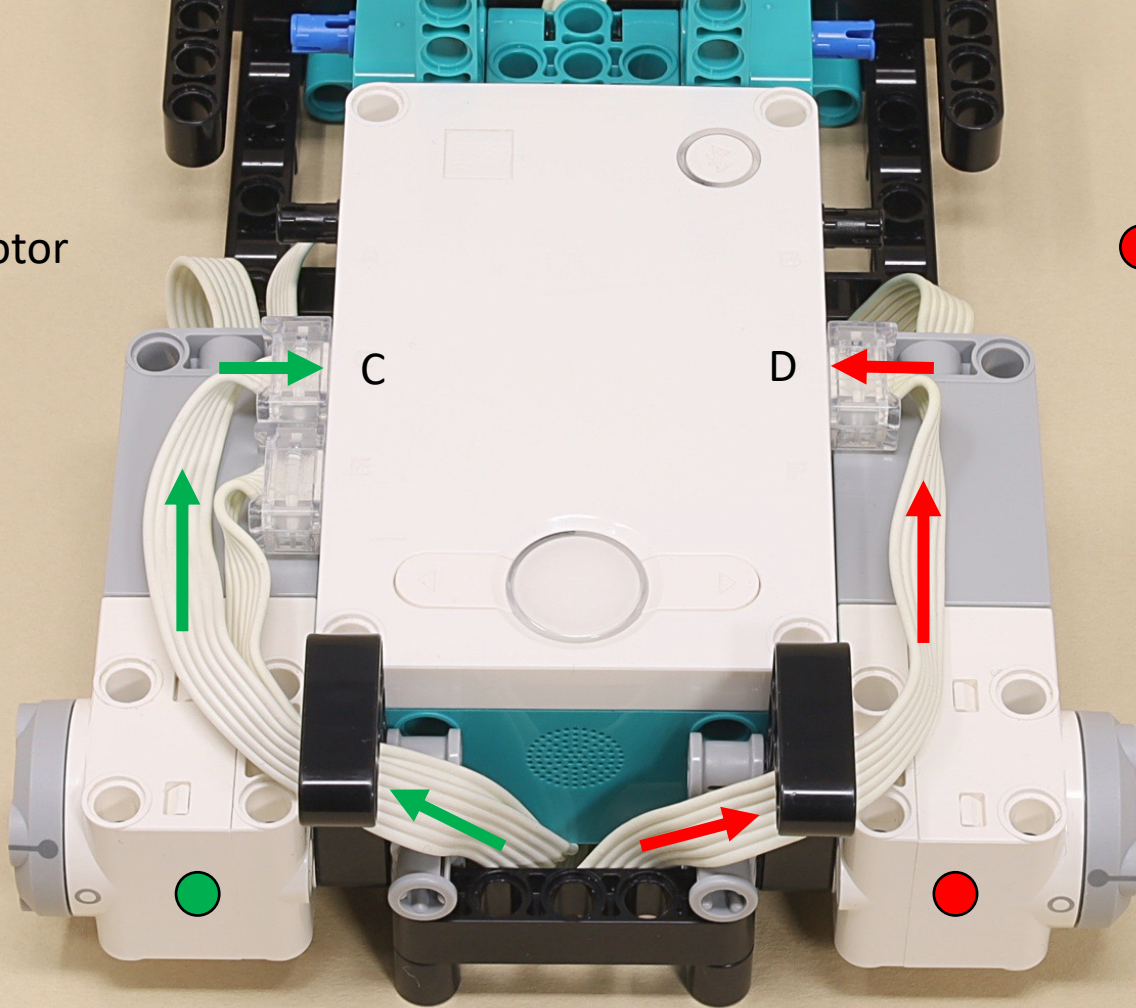

Pull the wire slack to the bottom side of the model.

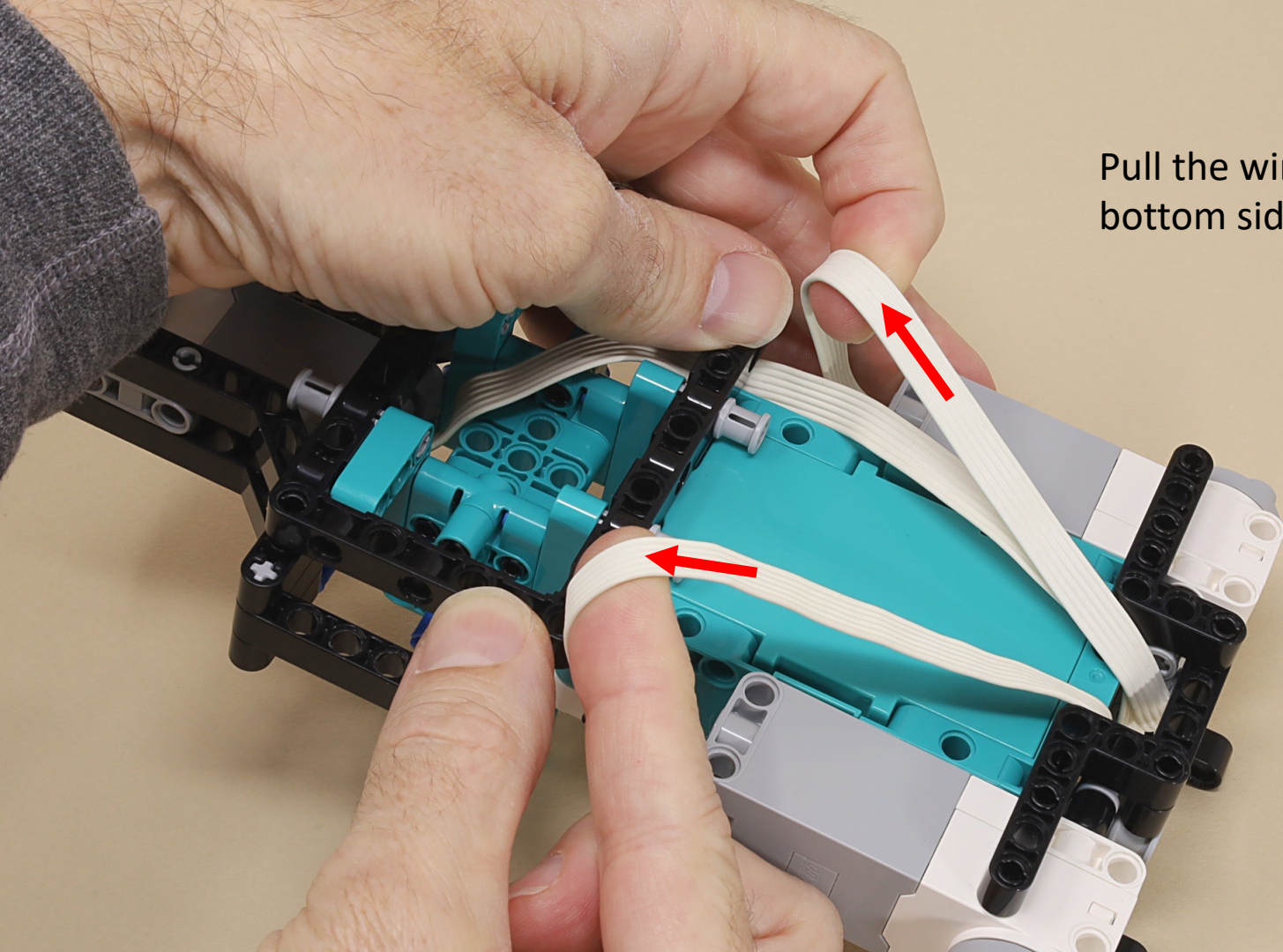



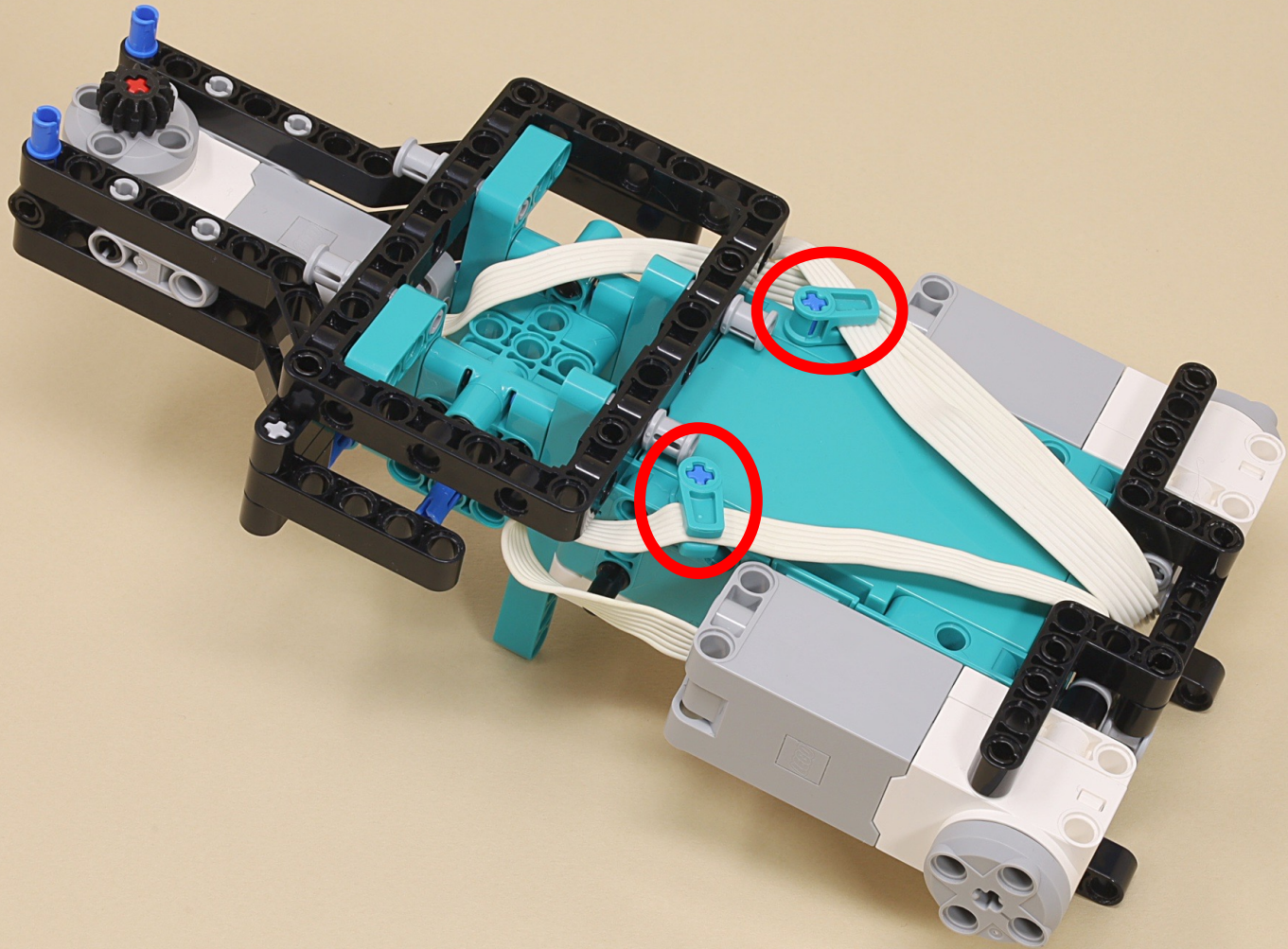

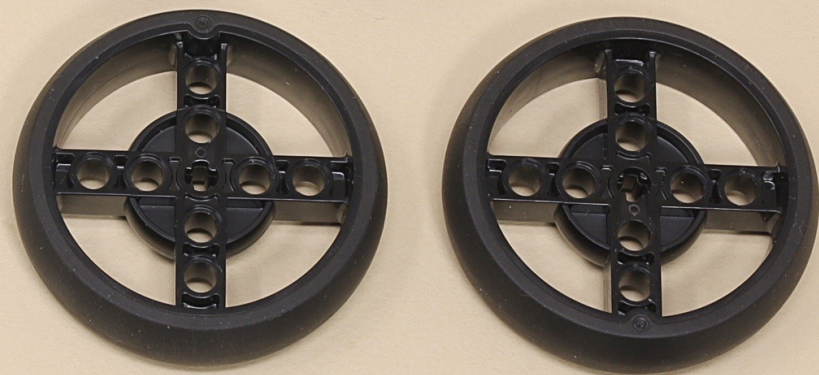
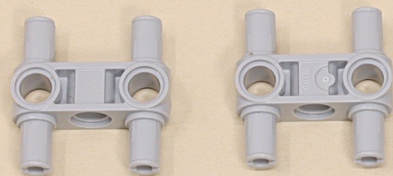
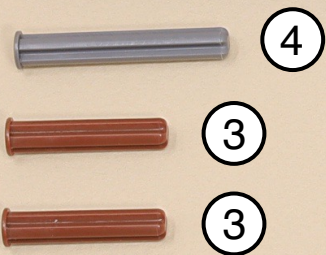
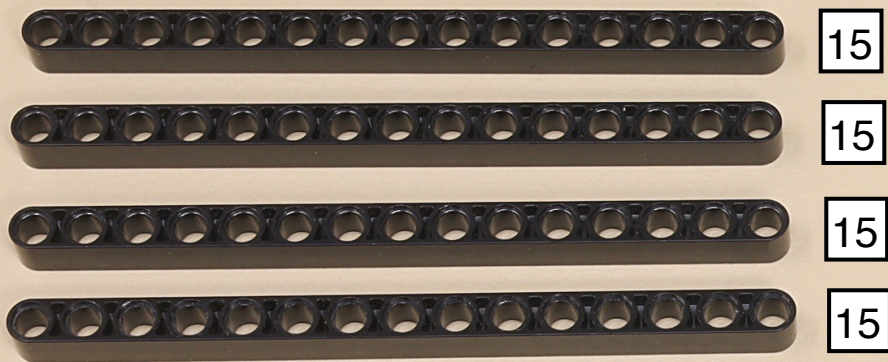

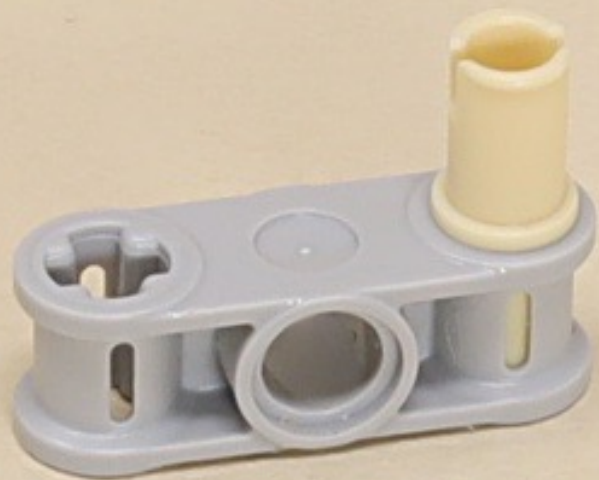

(center hole)

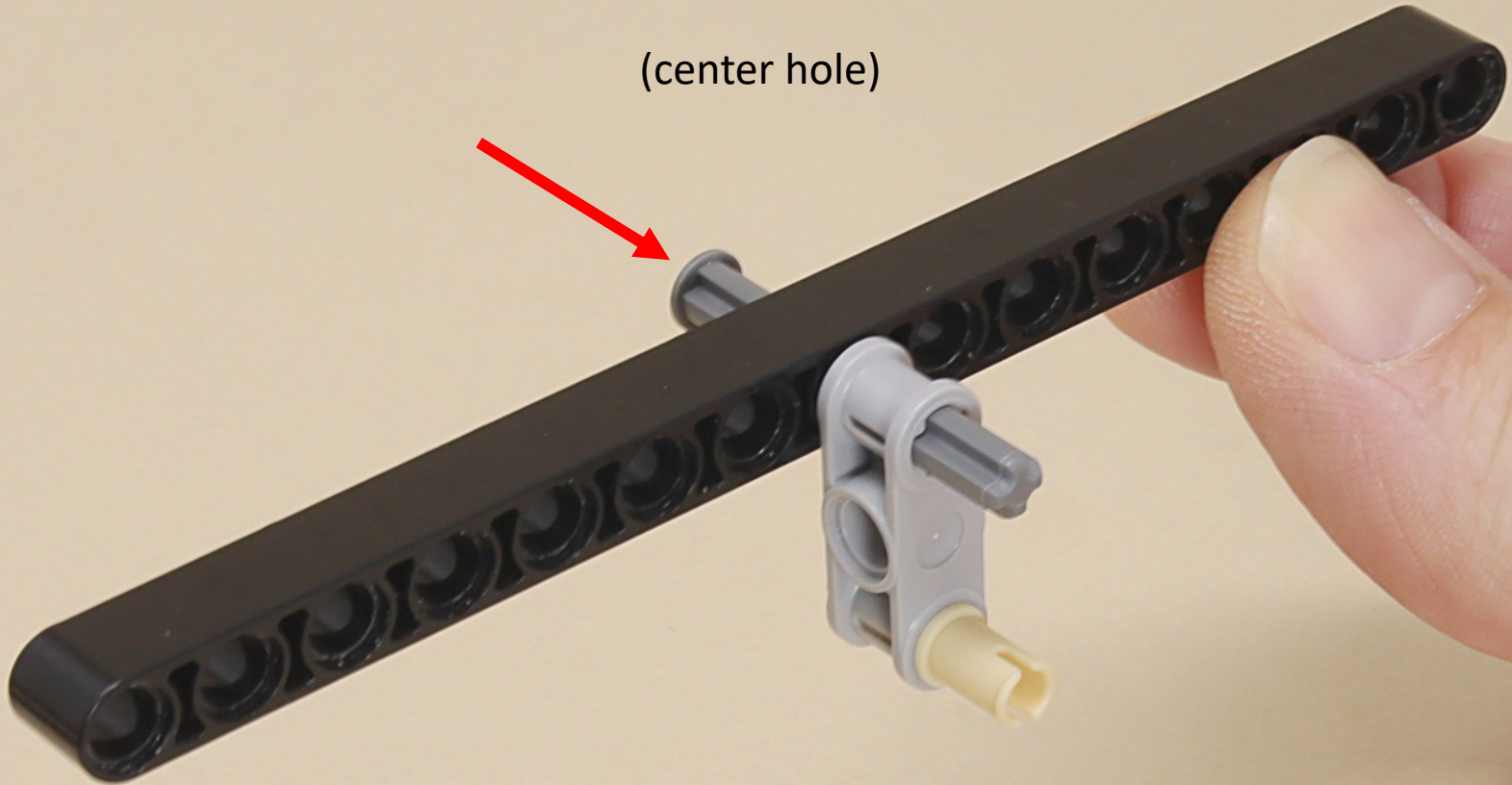

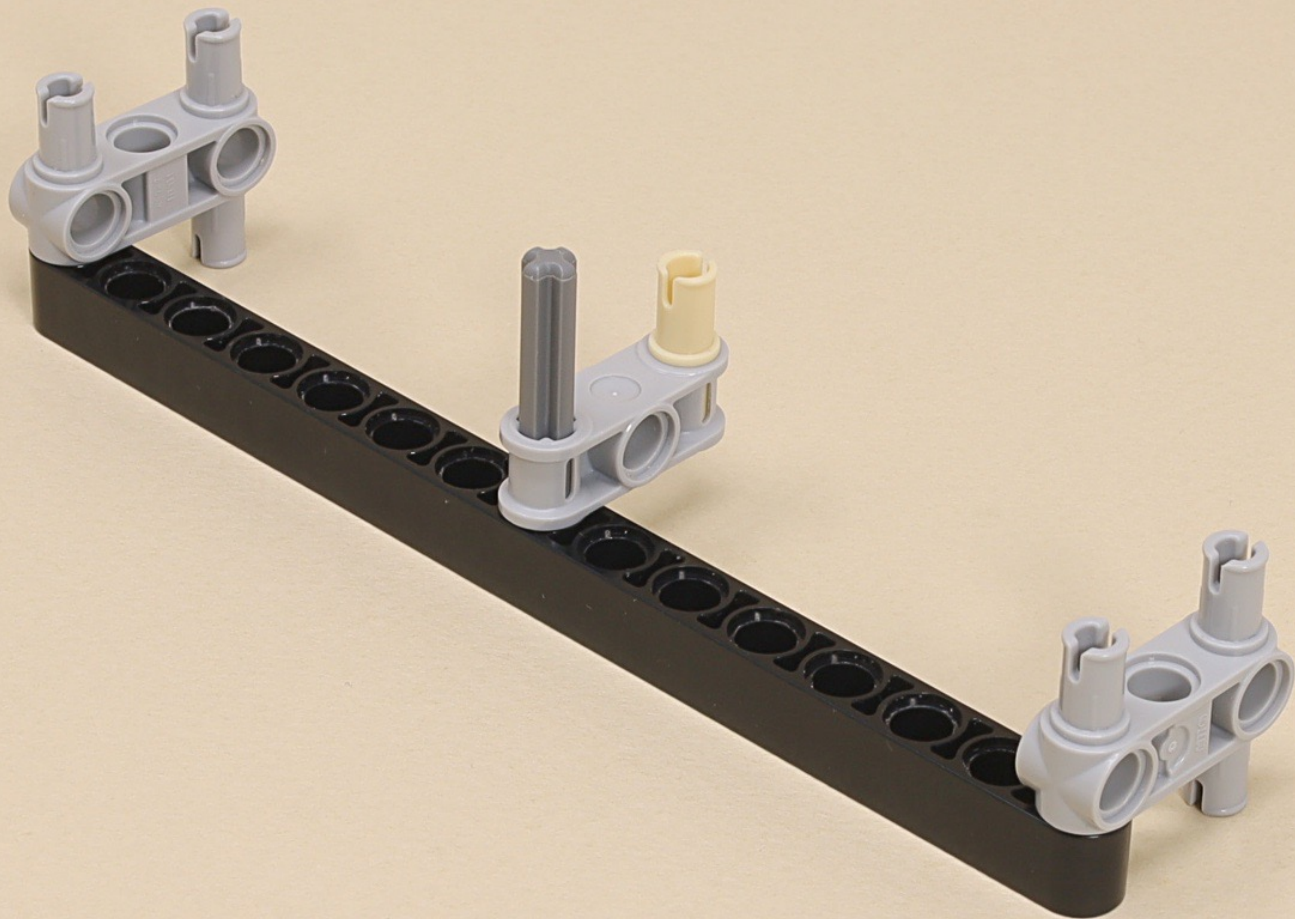

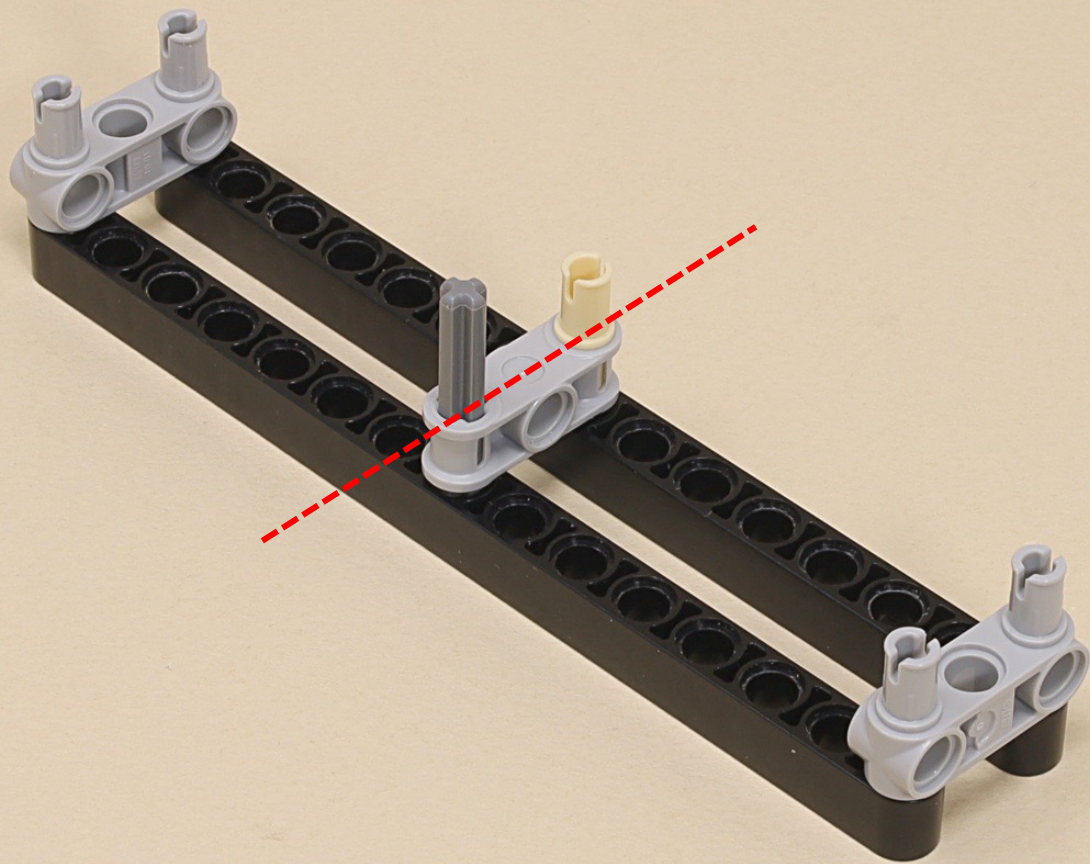

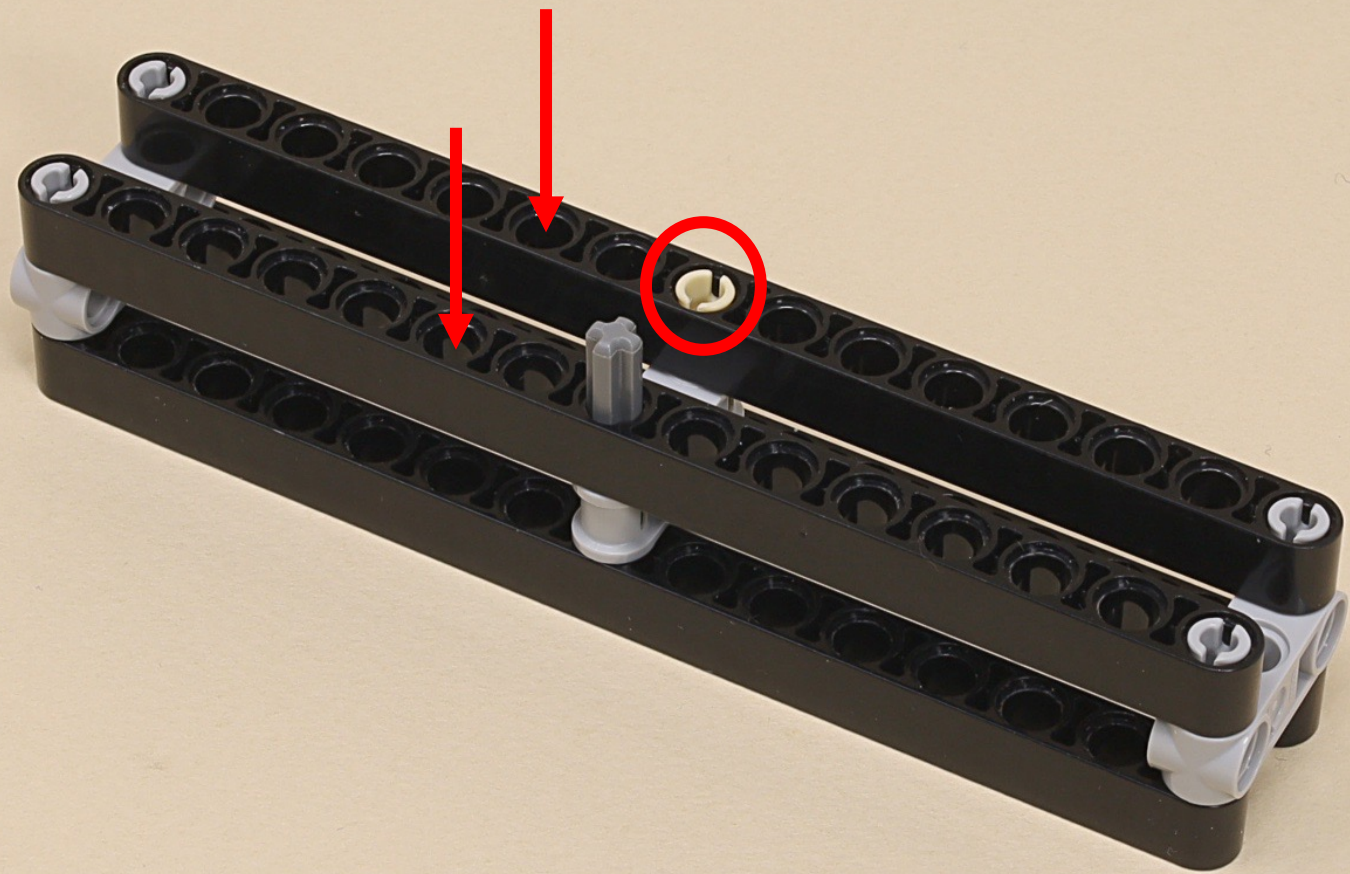

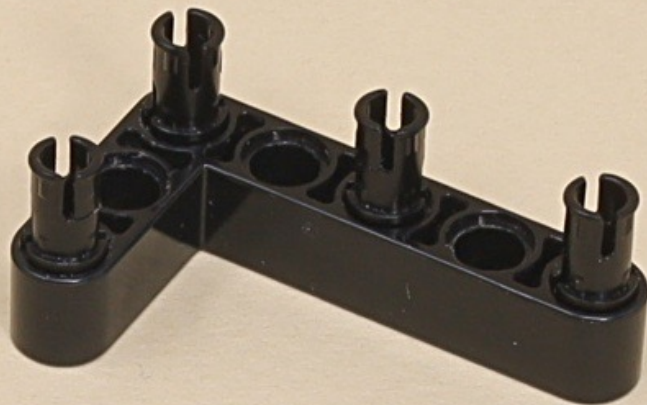
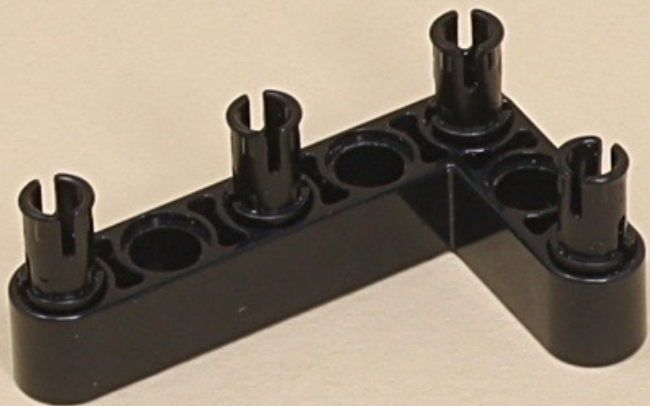

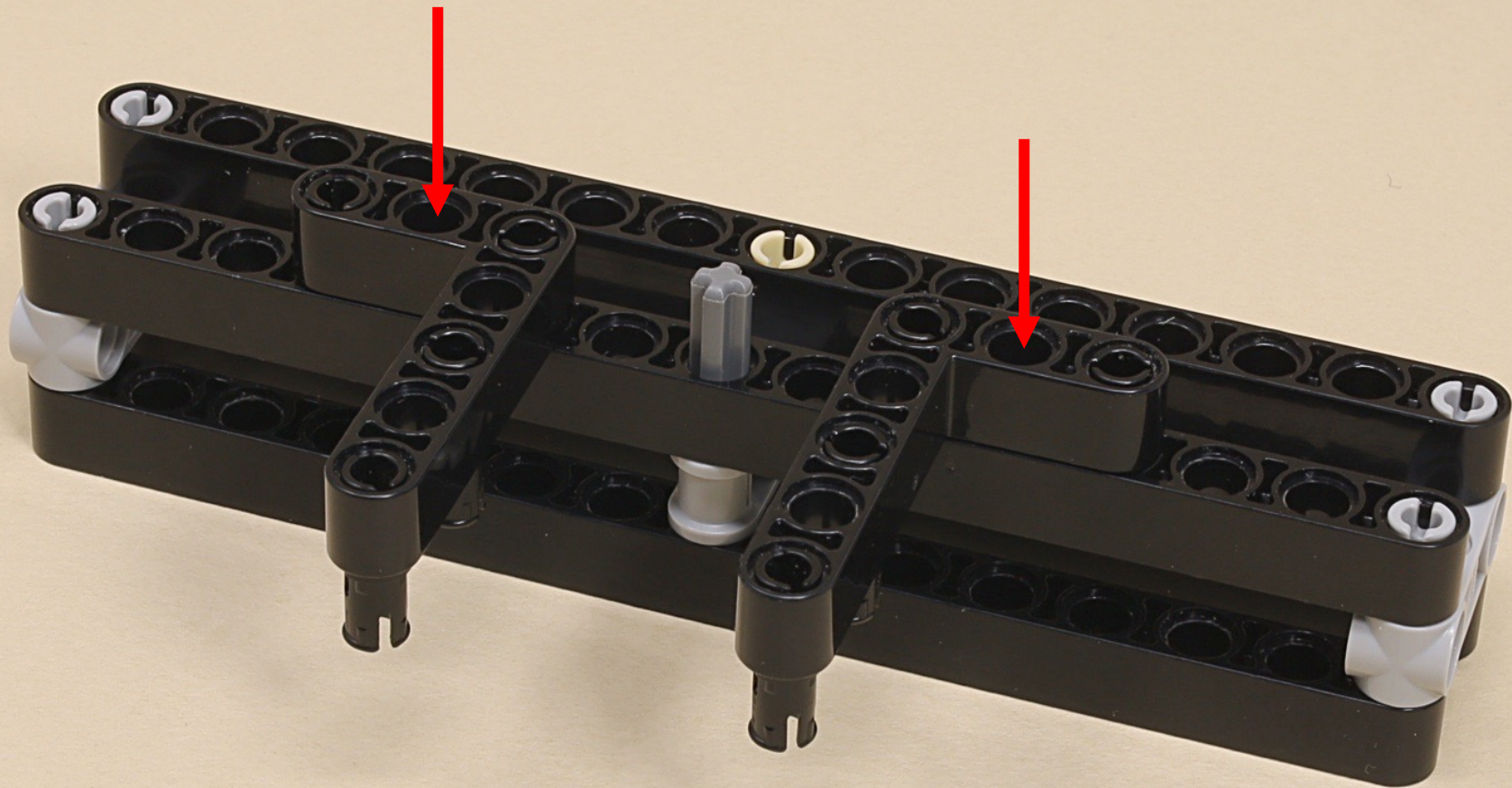



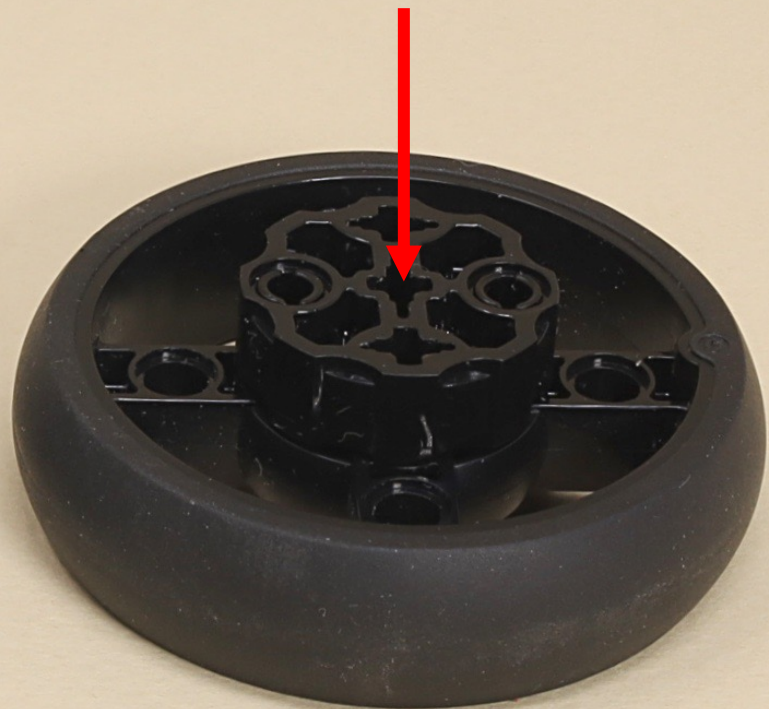
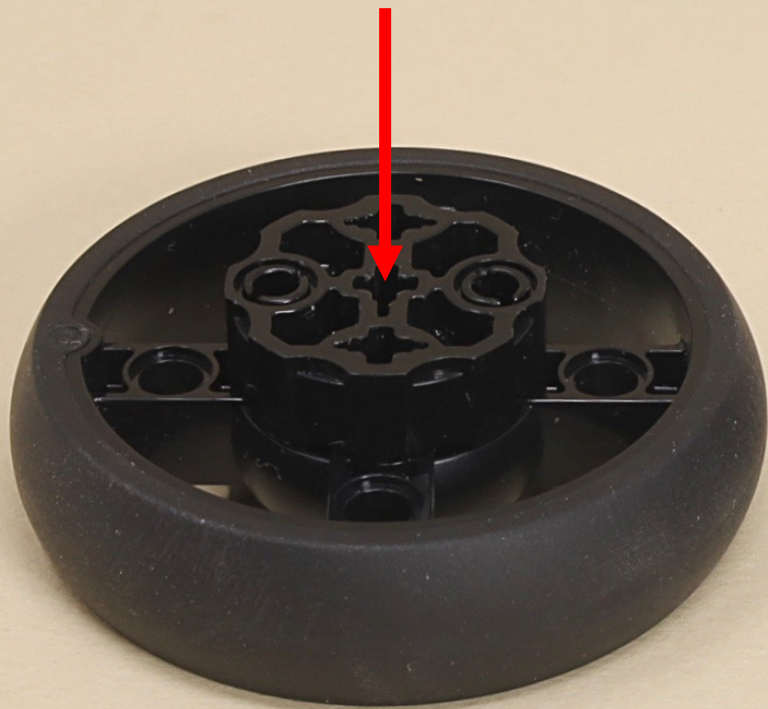

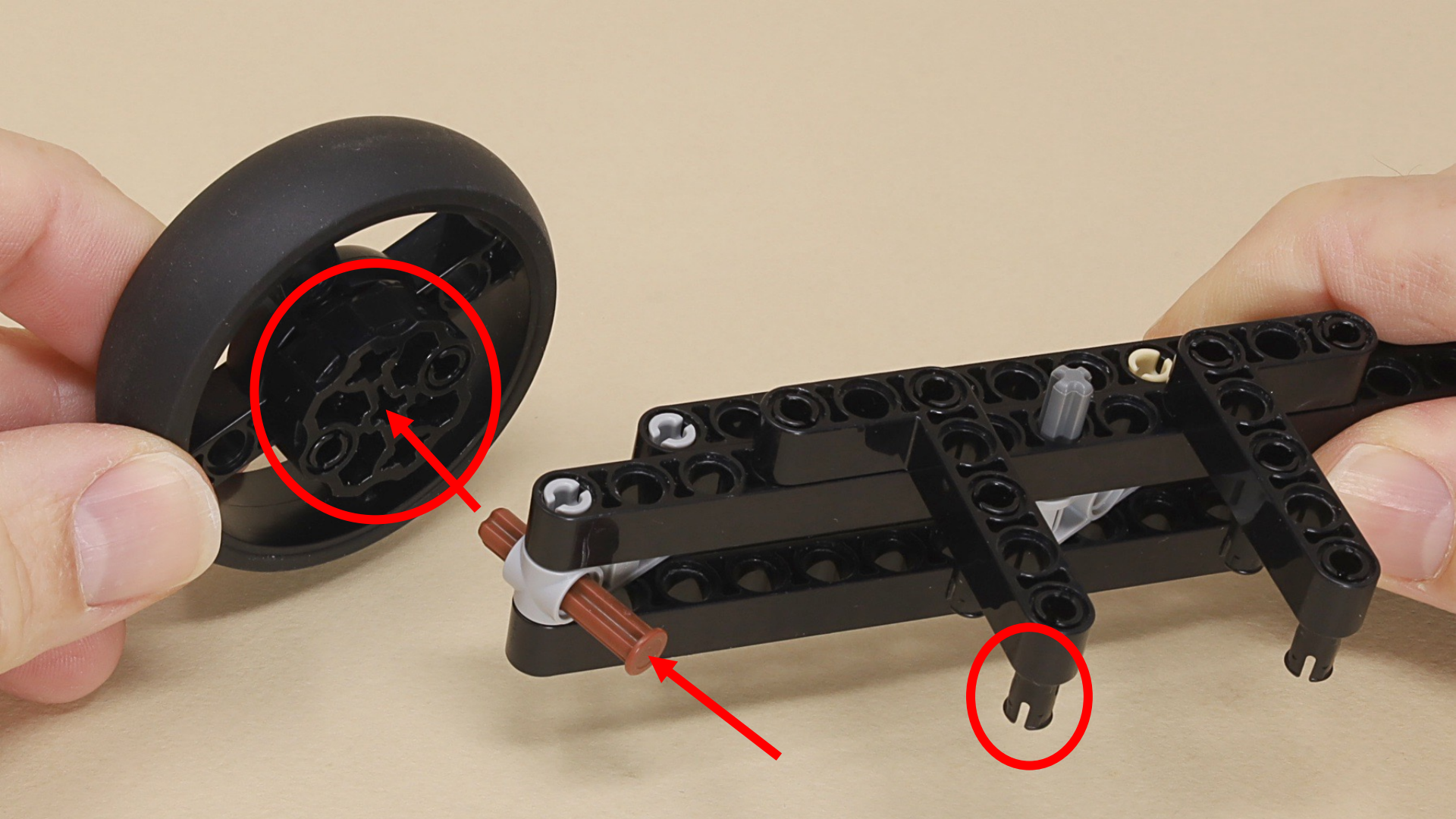

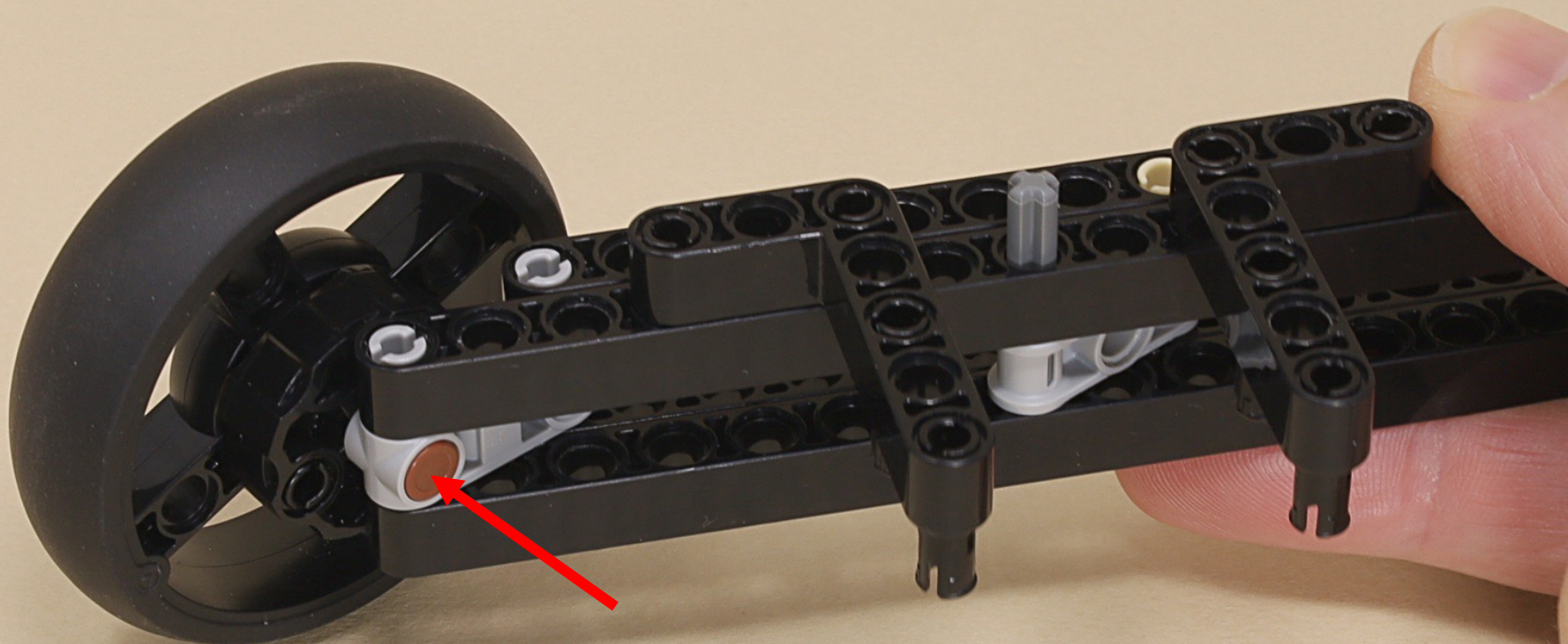

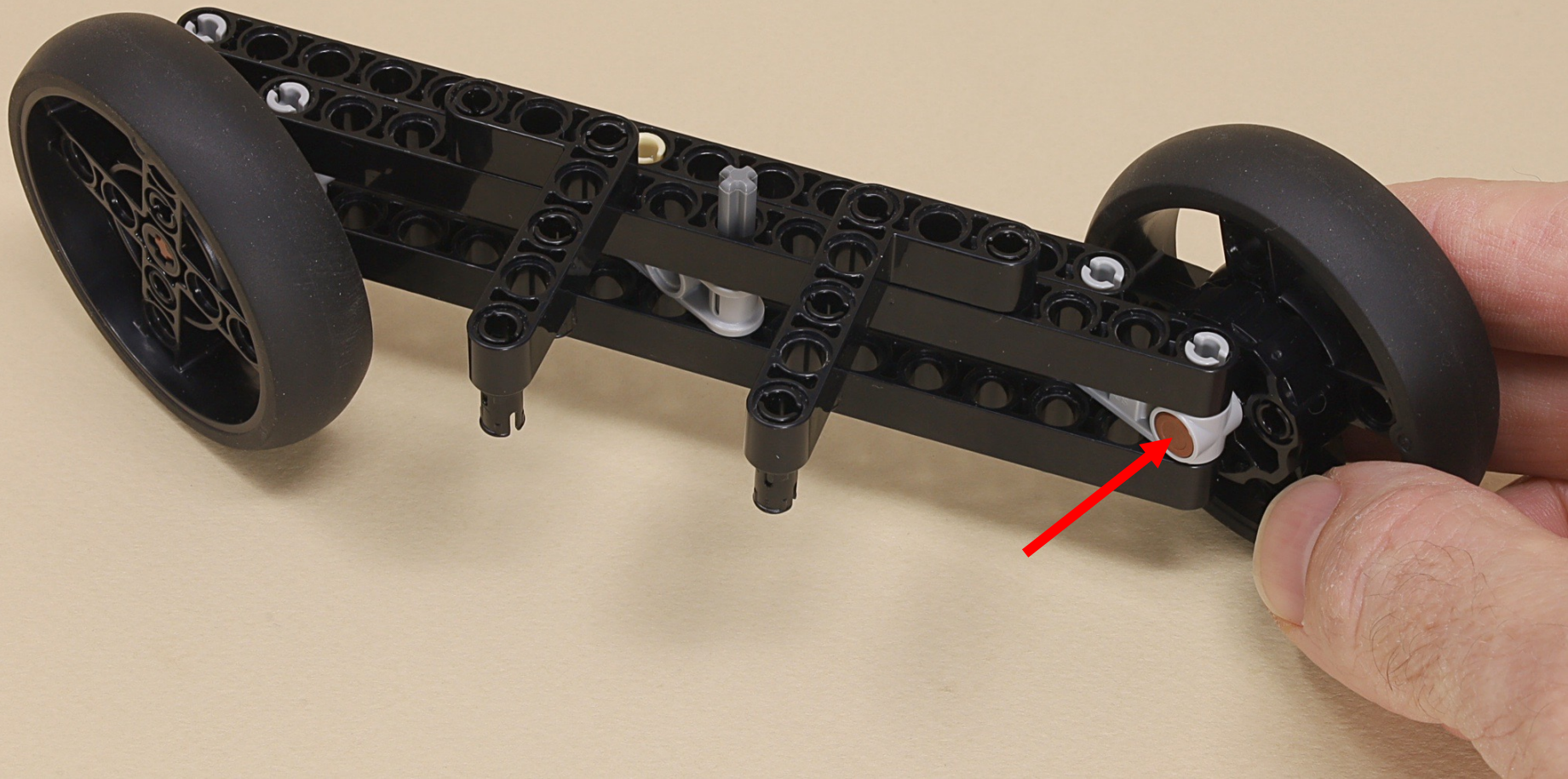

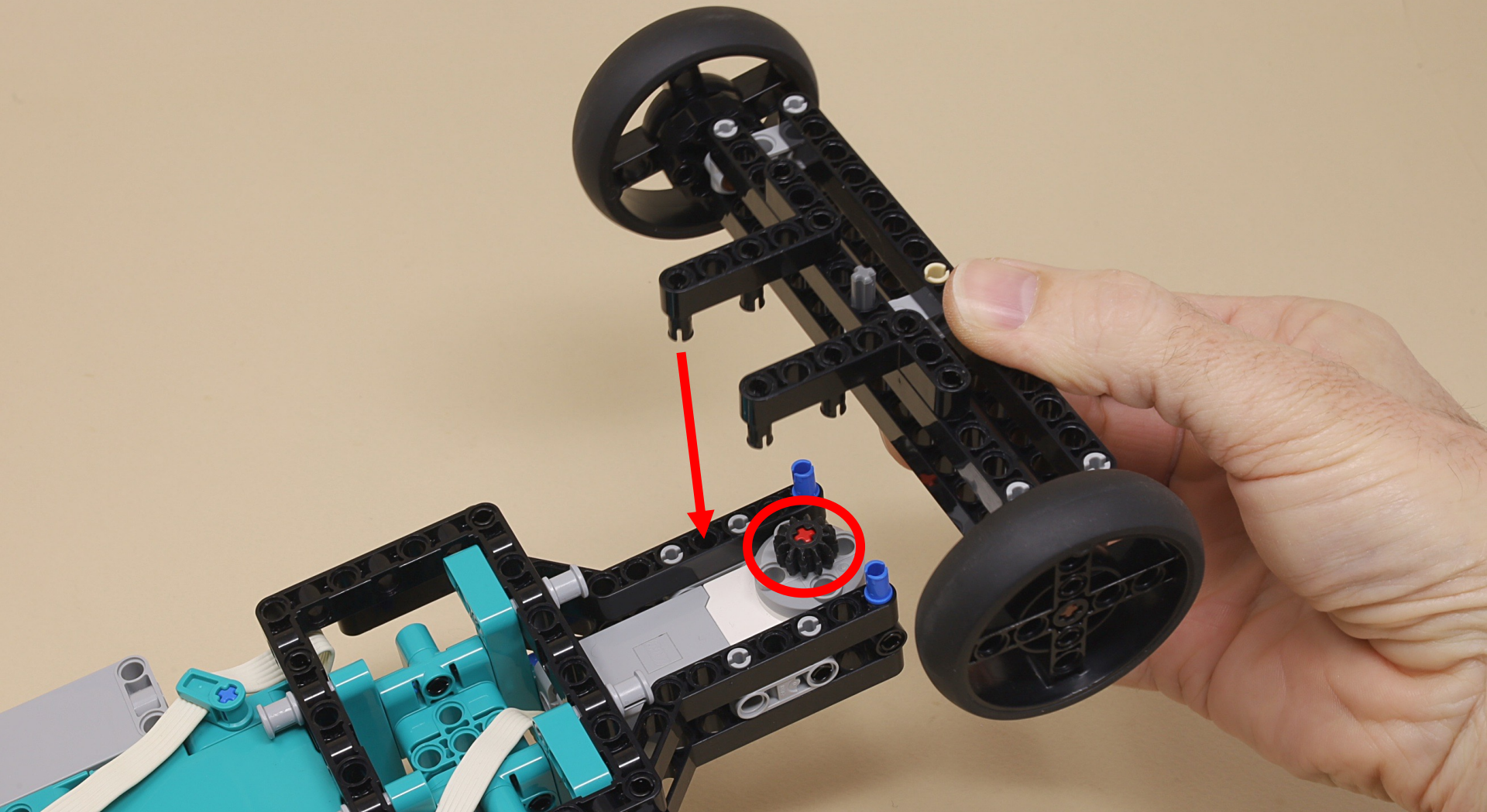

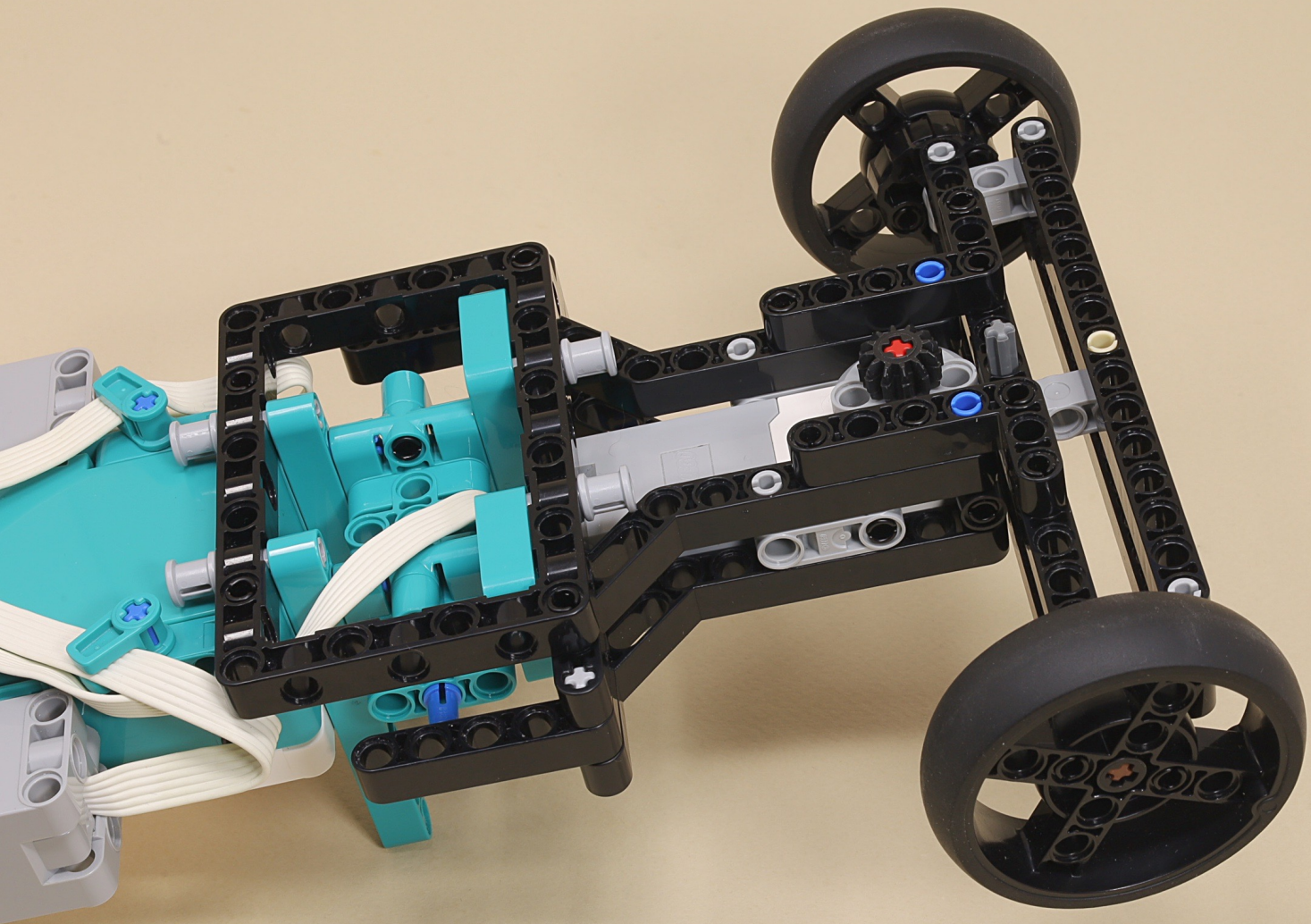

Because of the gears, it is not possible to get the wheels perfectly straight with the steering motor in its zero position. Keep the motor aligned to its zero position, then insert the beige gear with the wheels as close to straight as possible, with the slight error in the direction shown below. The program will compensate for this error.

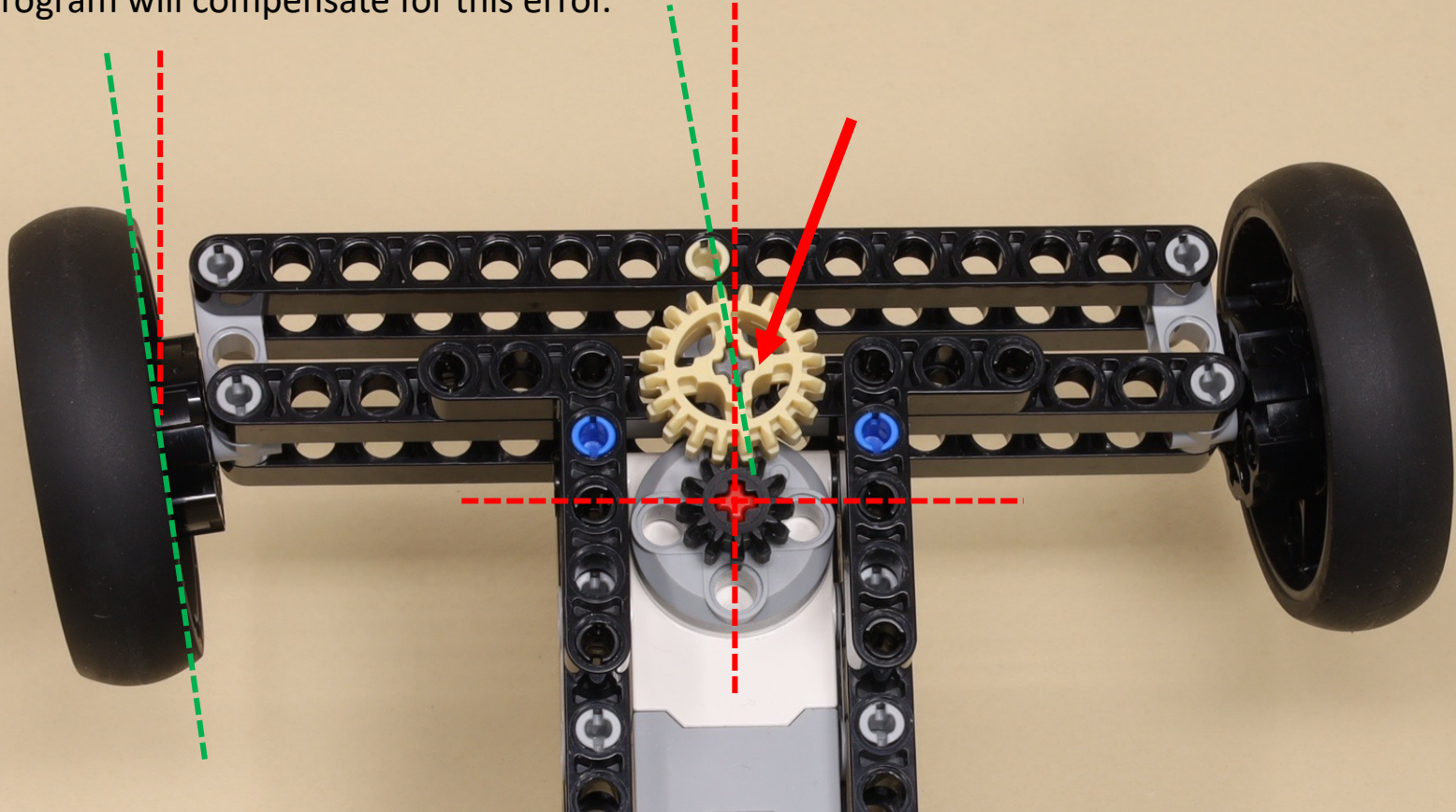

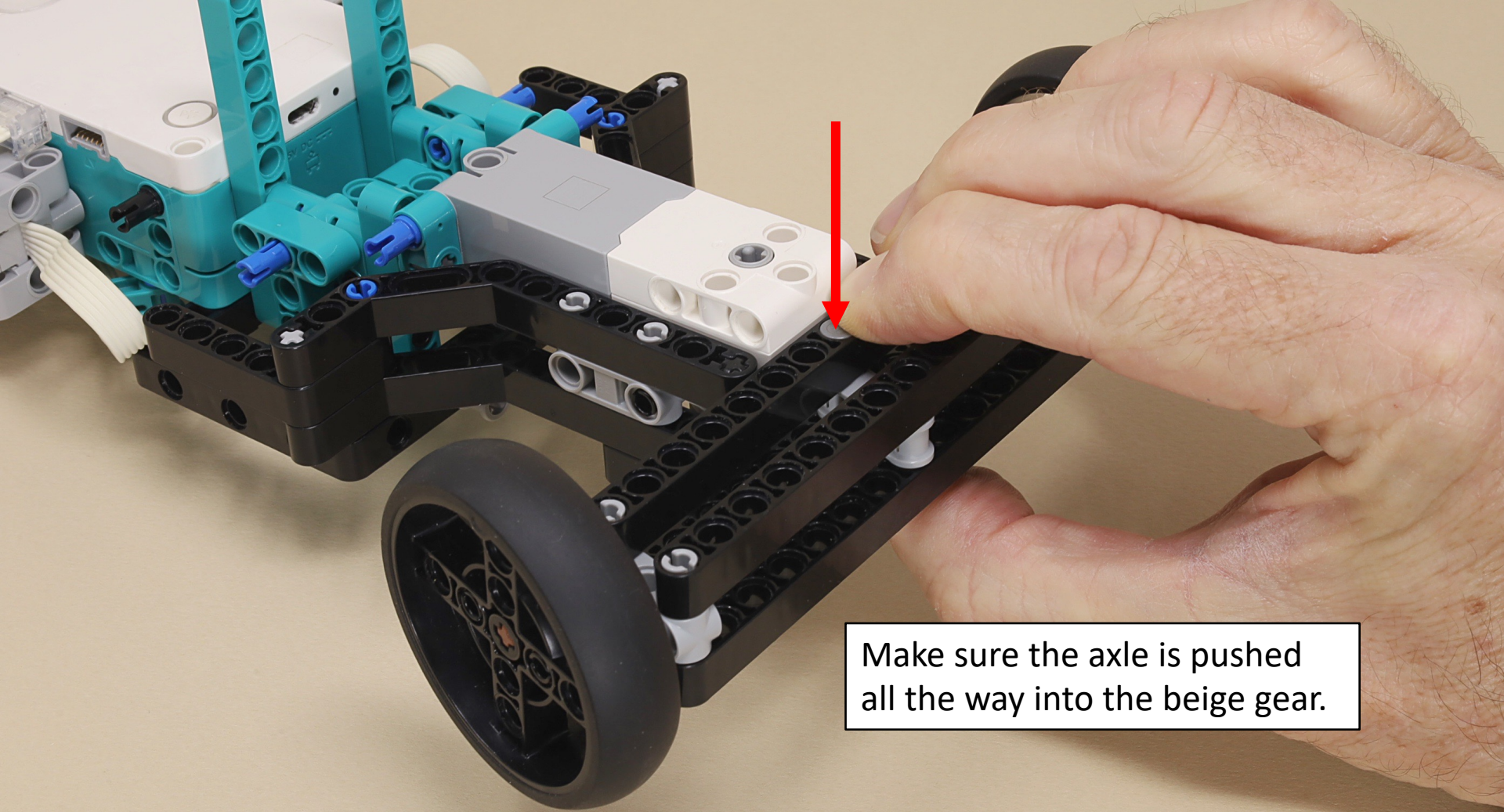

Make sure the axle is pushed all the way into the beige gear.

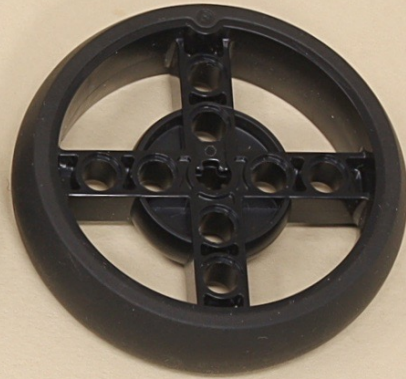
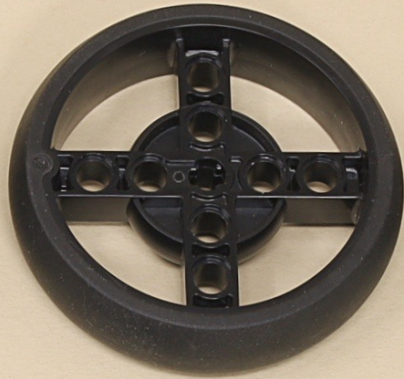
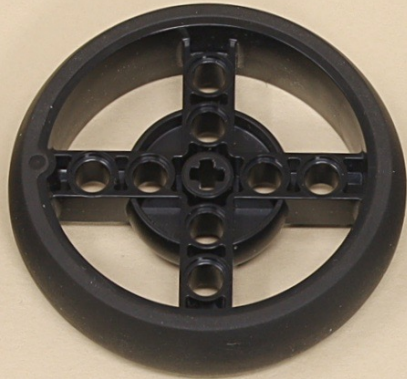
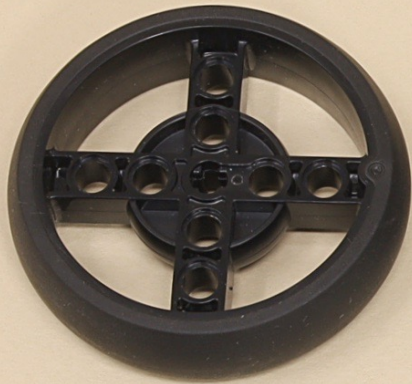

4



4



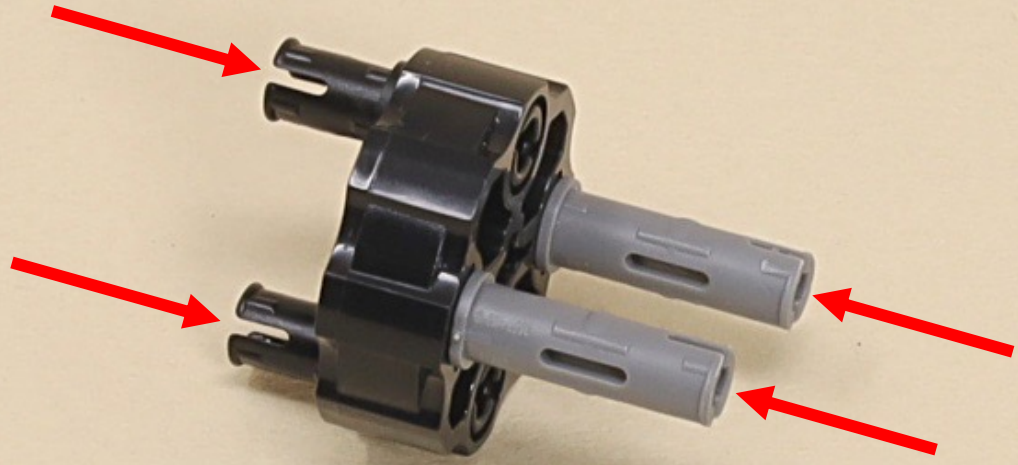



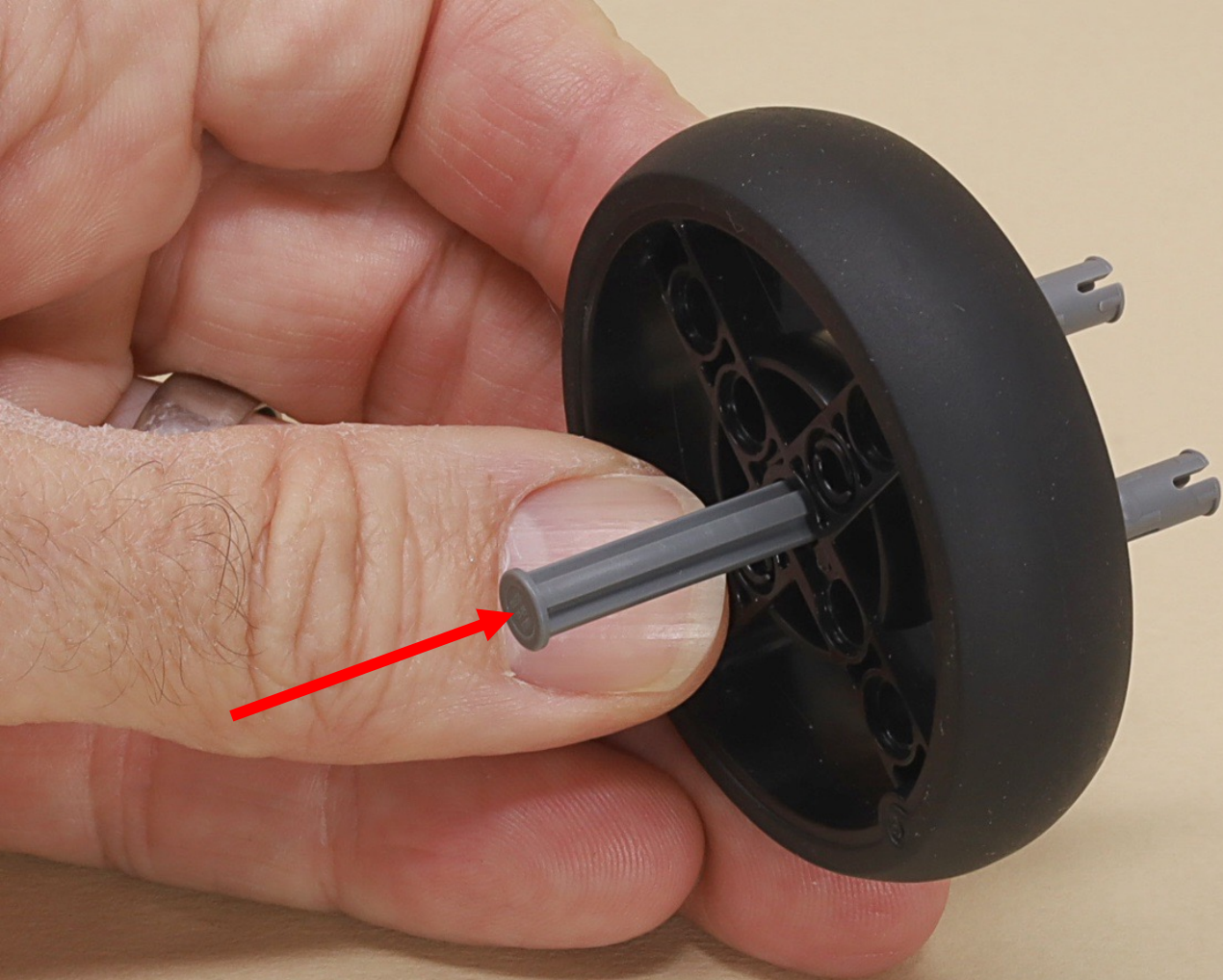

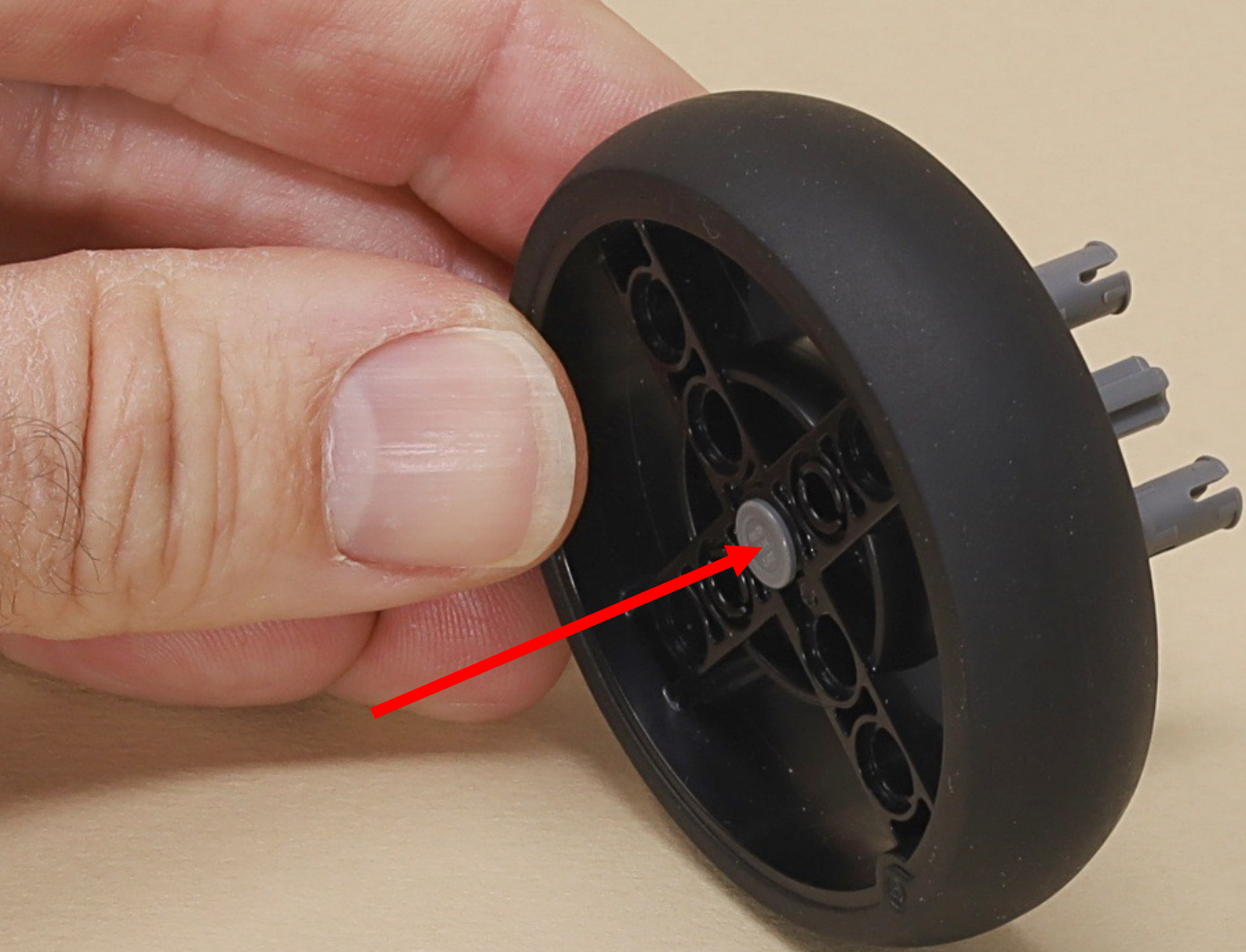



(2 x)

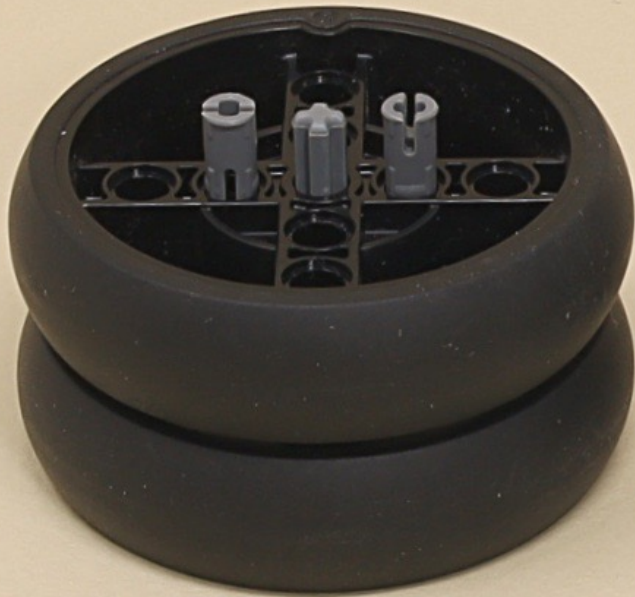

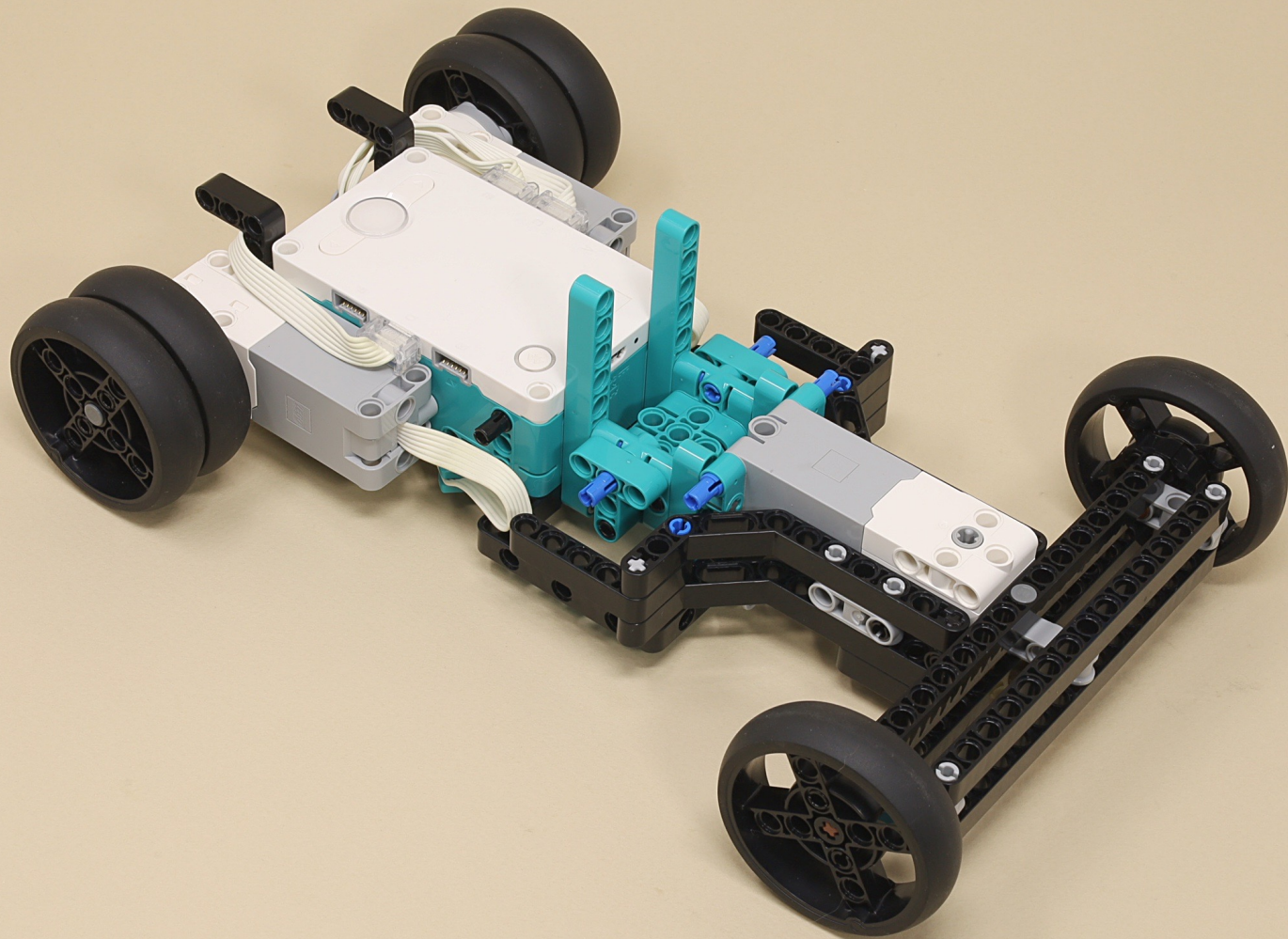

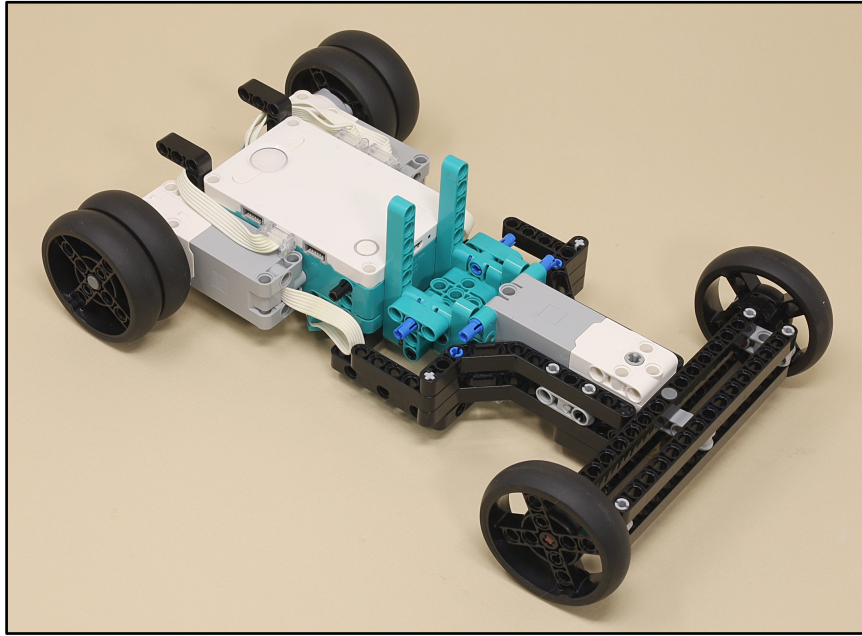

The chassis is now complete.
You can test drive it now if you want.

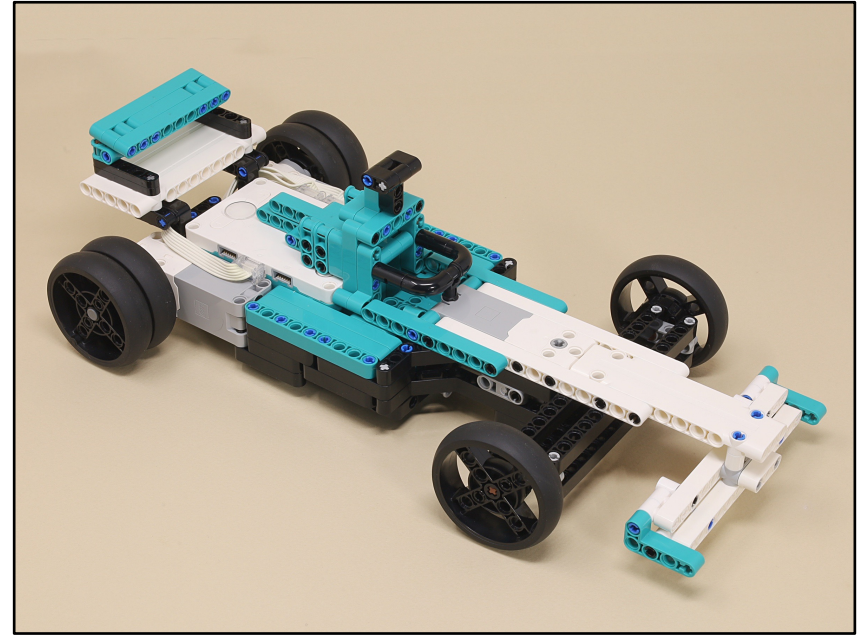

You can design your own bodywork,
or use the instructions included with
the project for this bodywork.