

Lawnmower

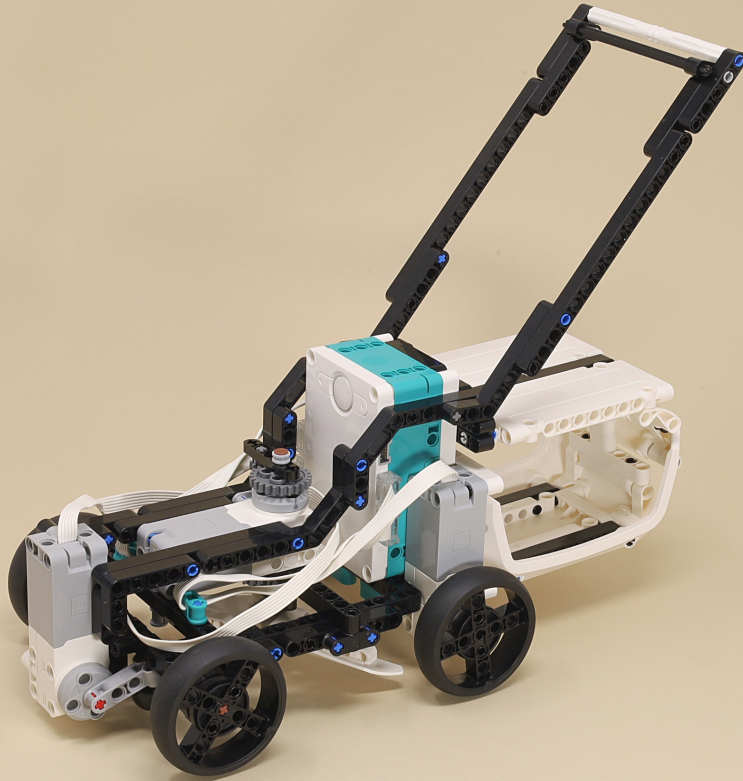

Scroll for
building
instructions





11



7



7



(6 x)

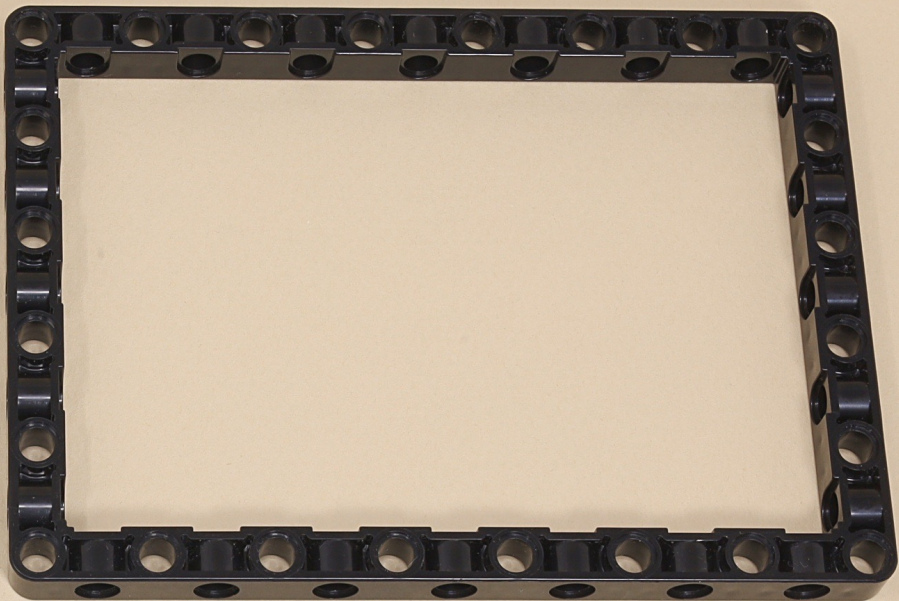

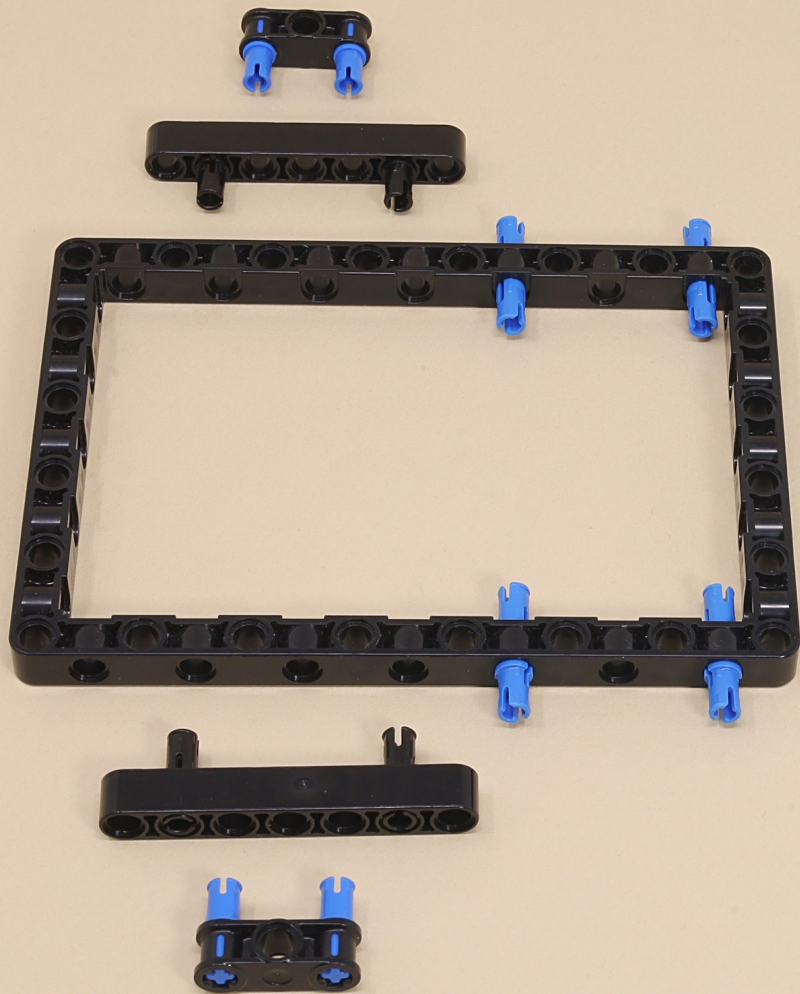

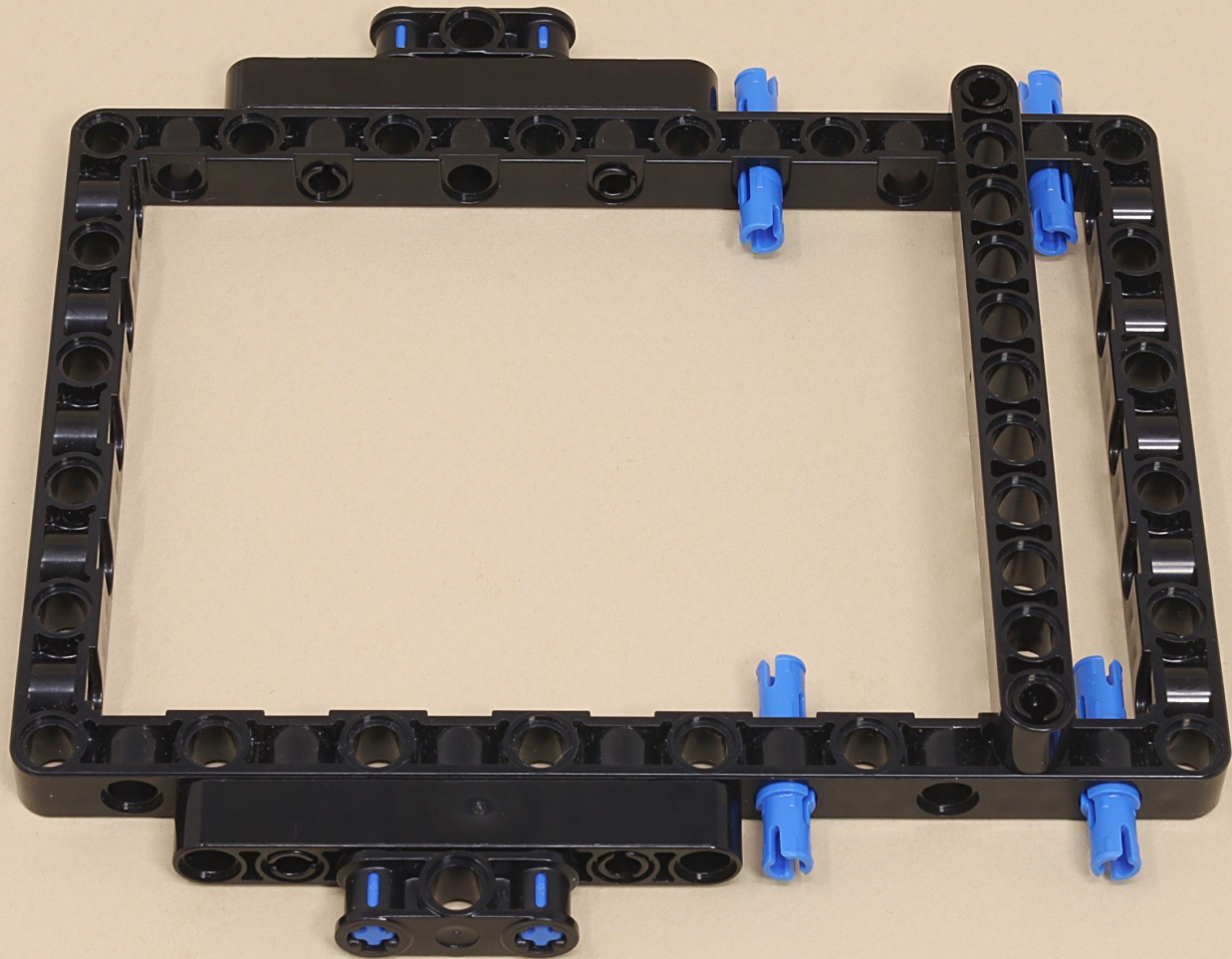



15



8



4





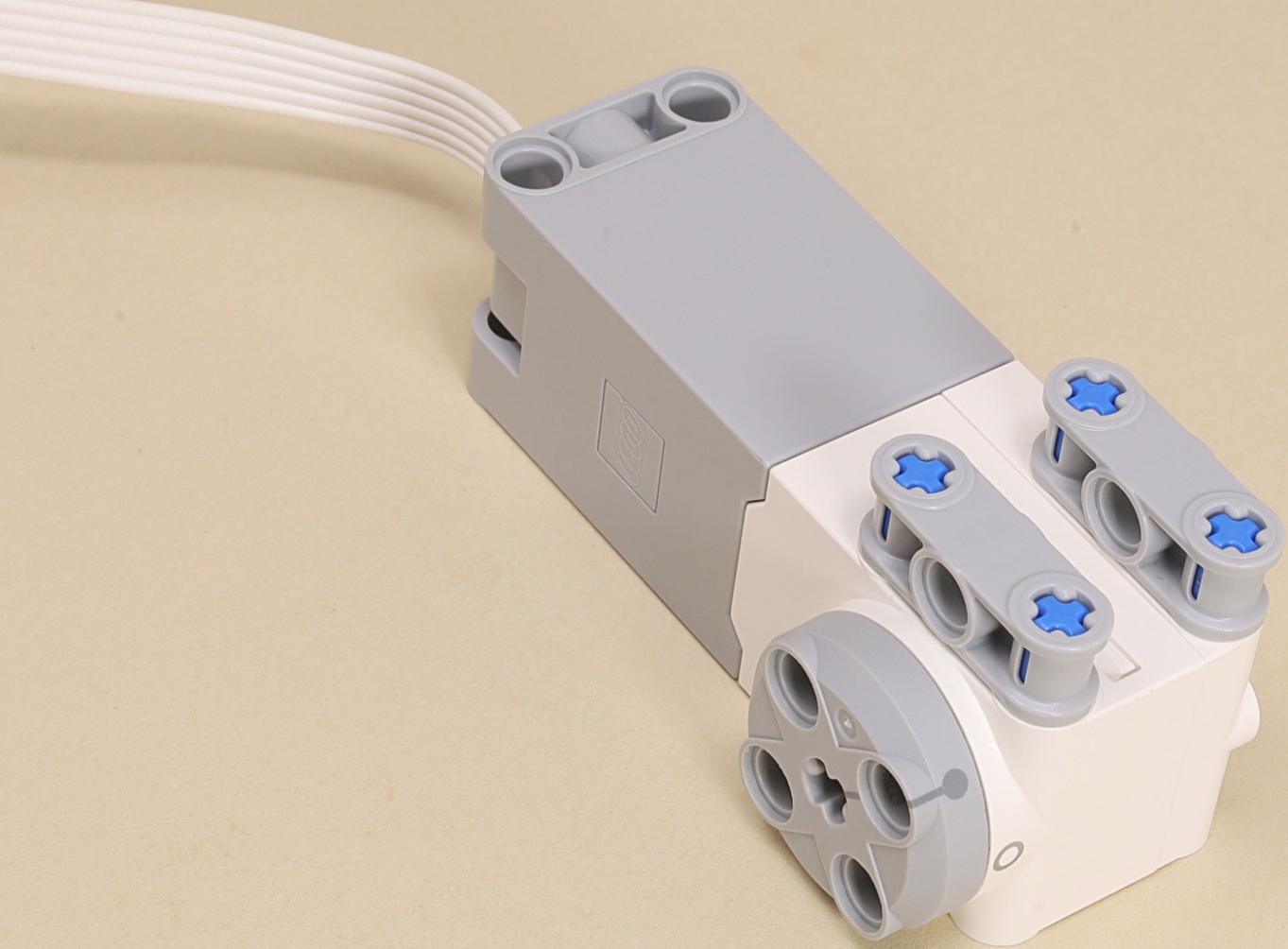

4

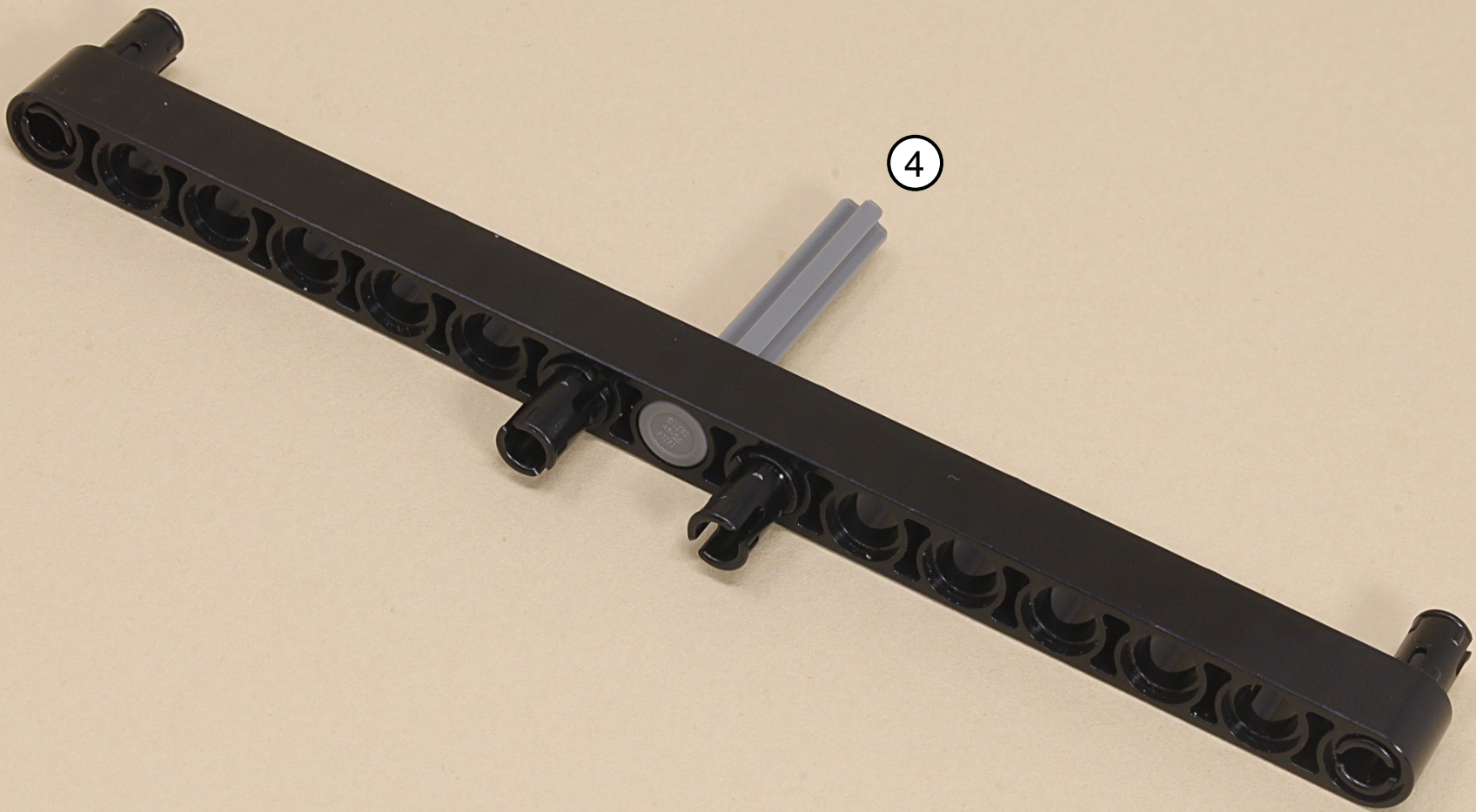

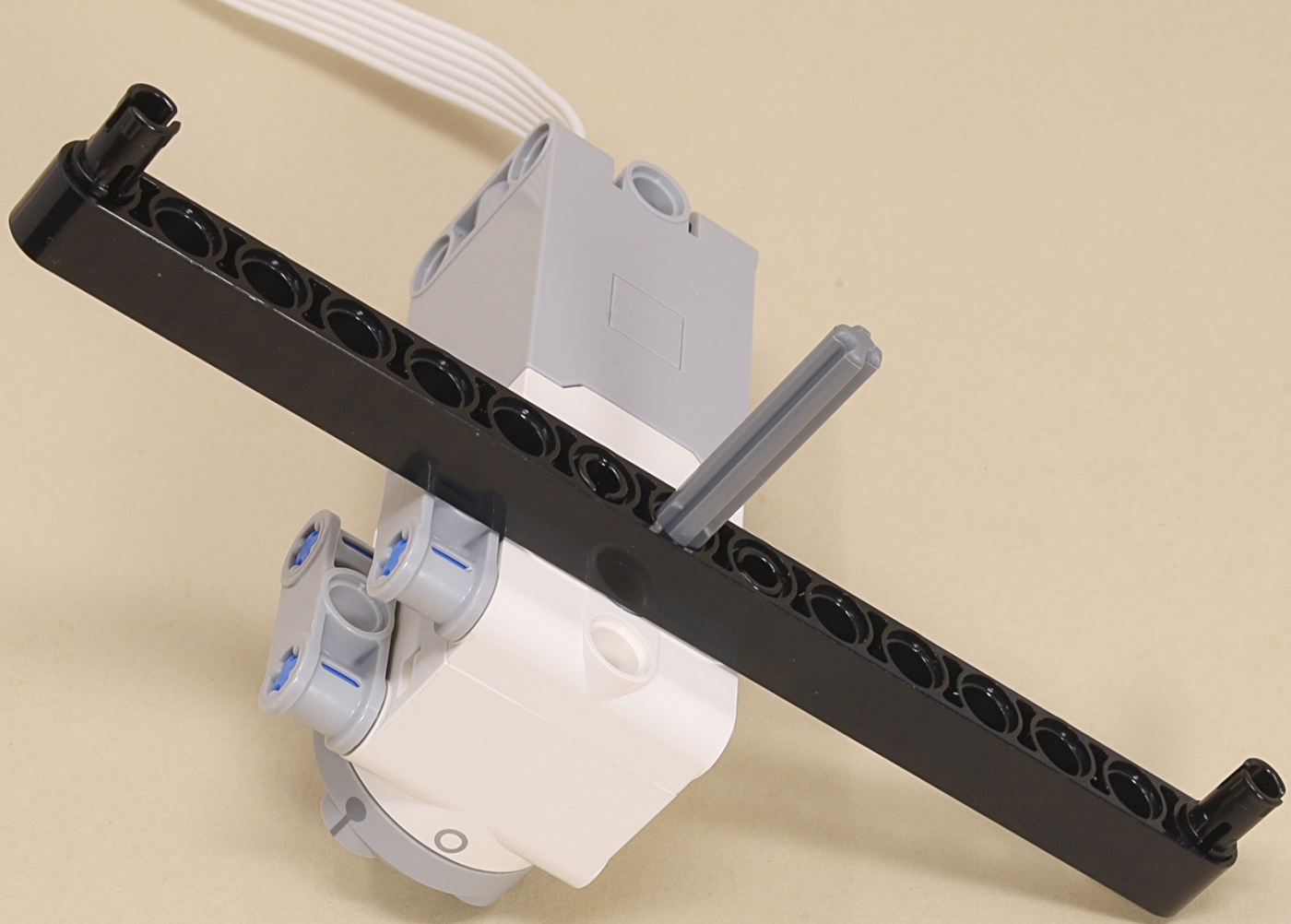

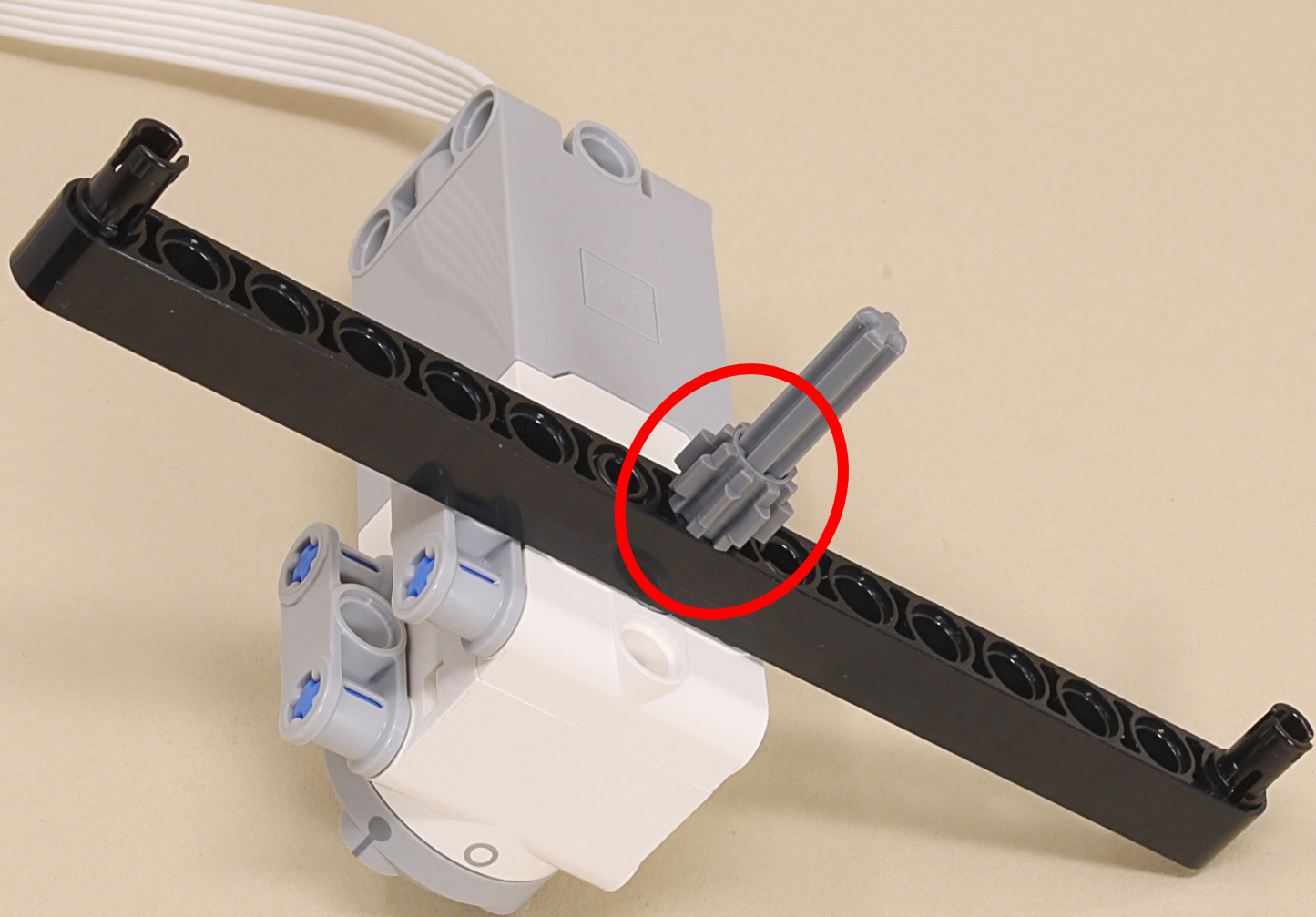

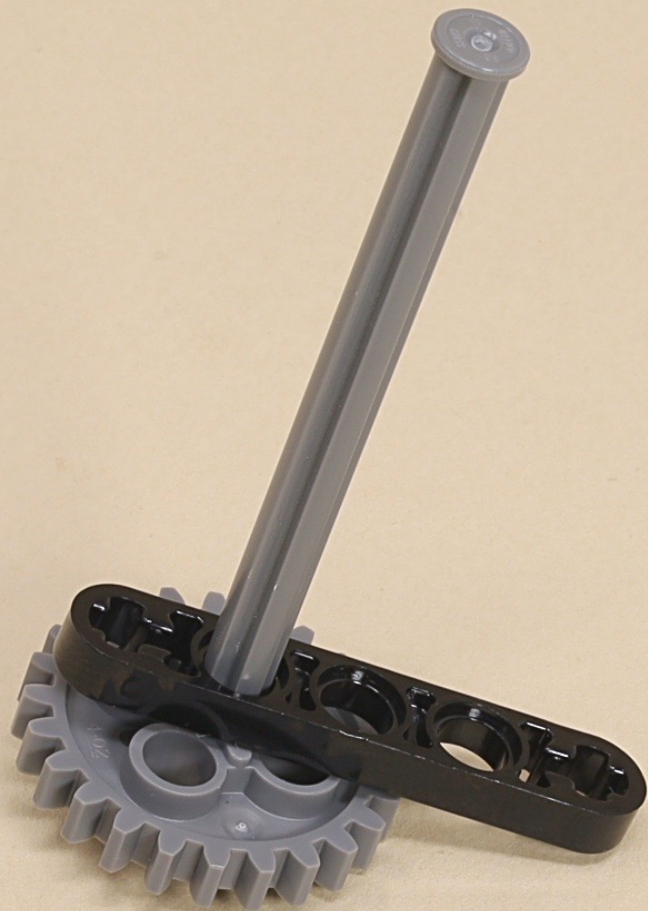

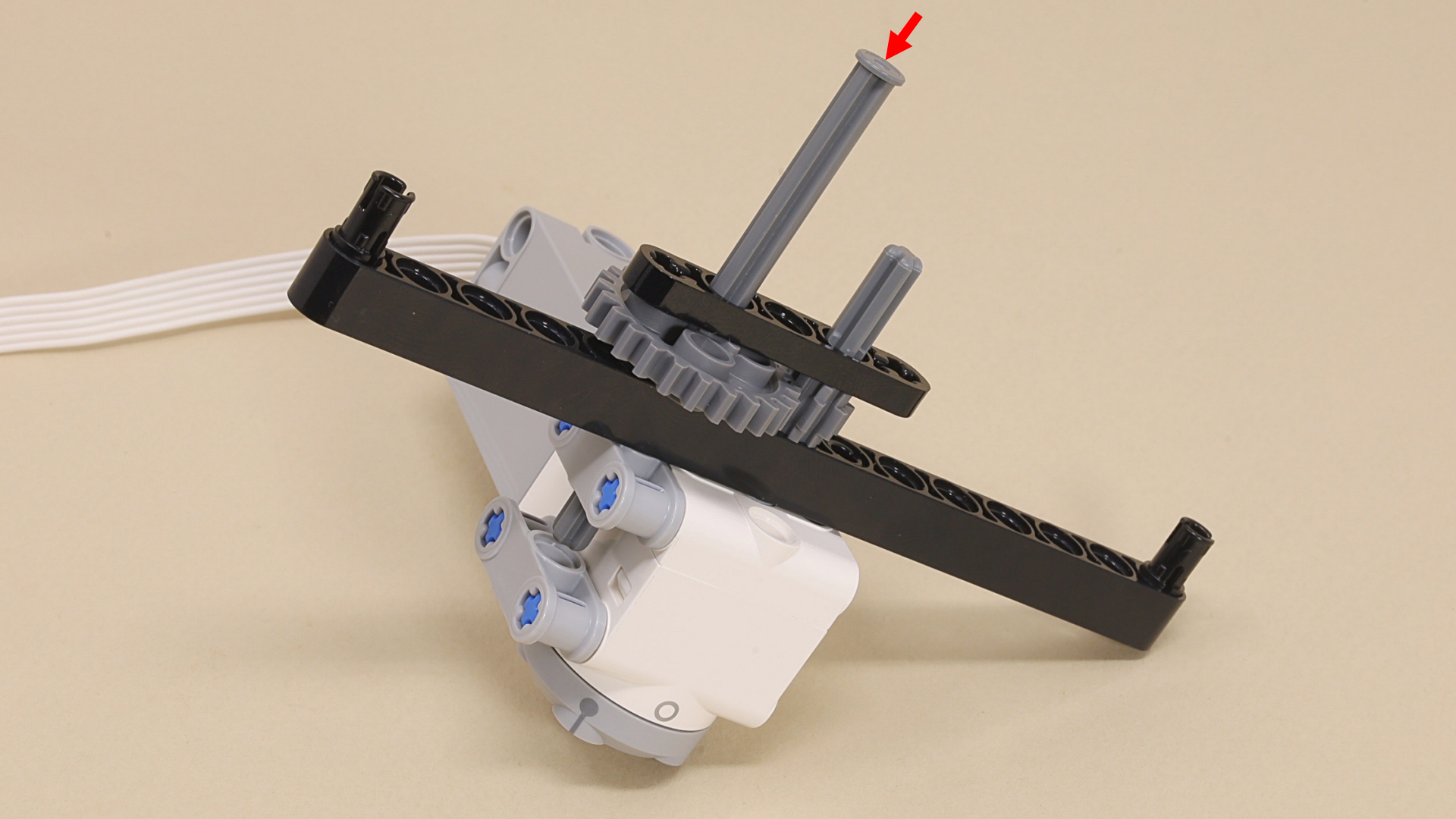

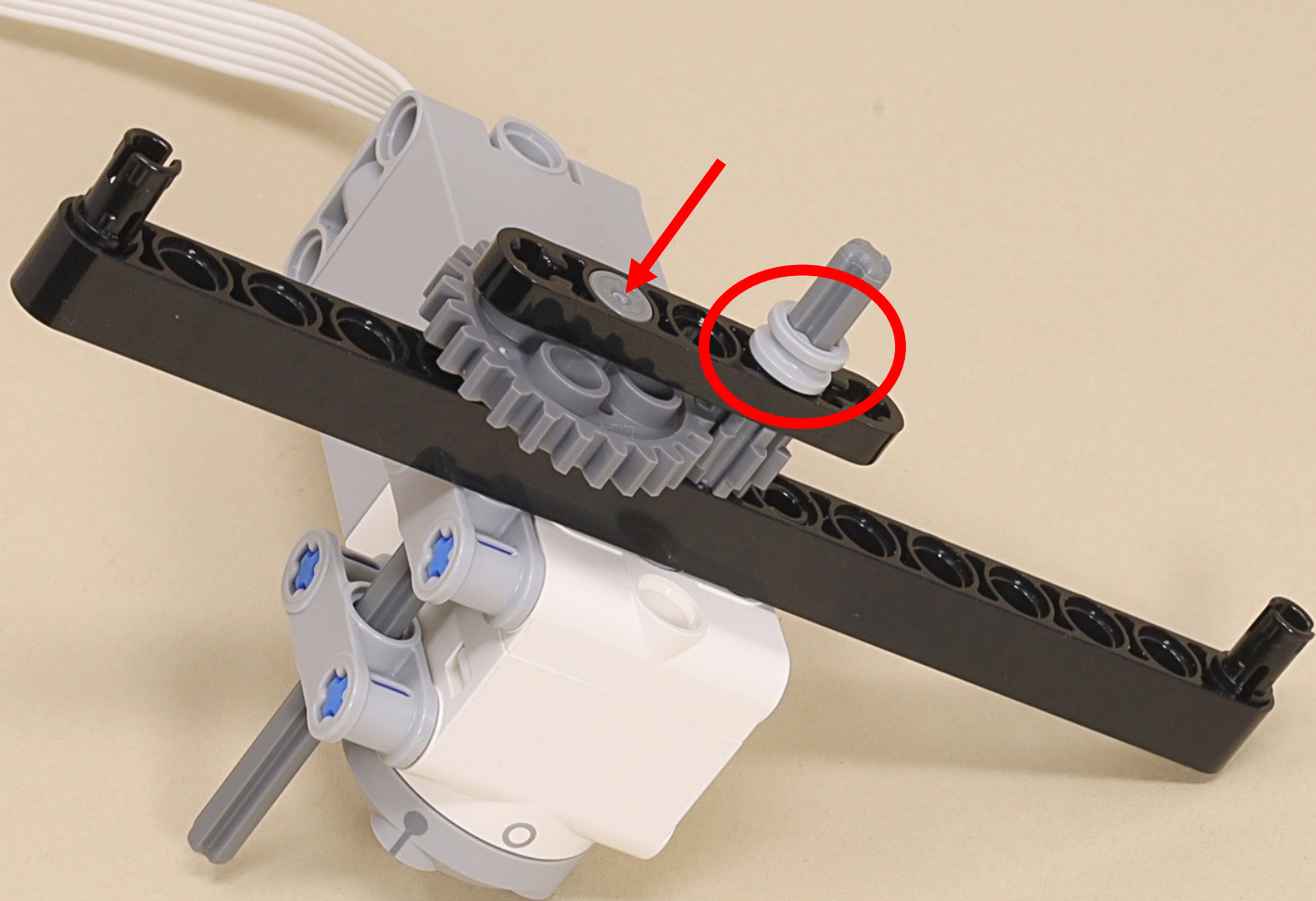



3



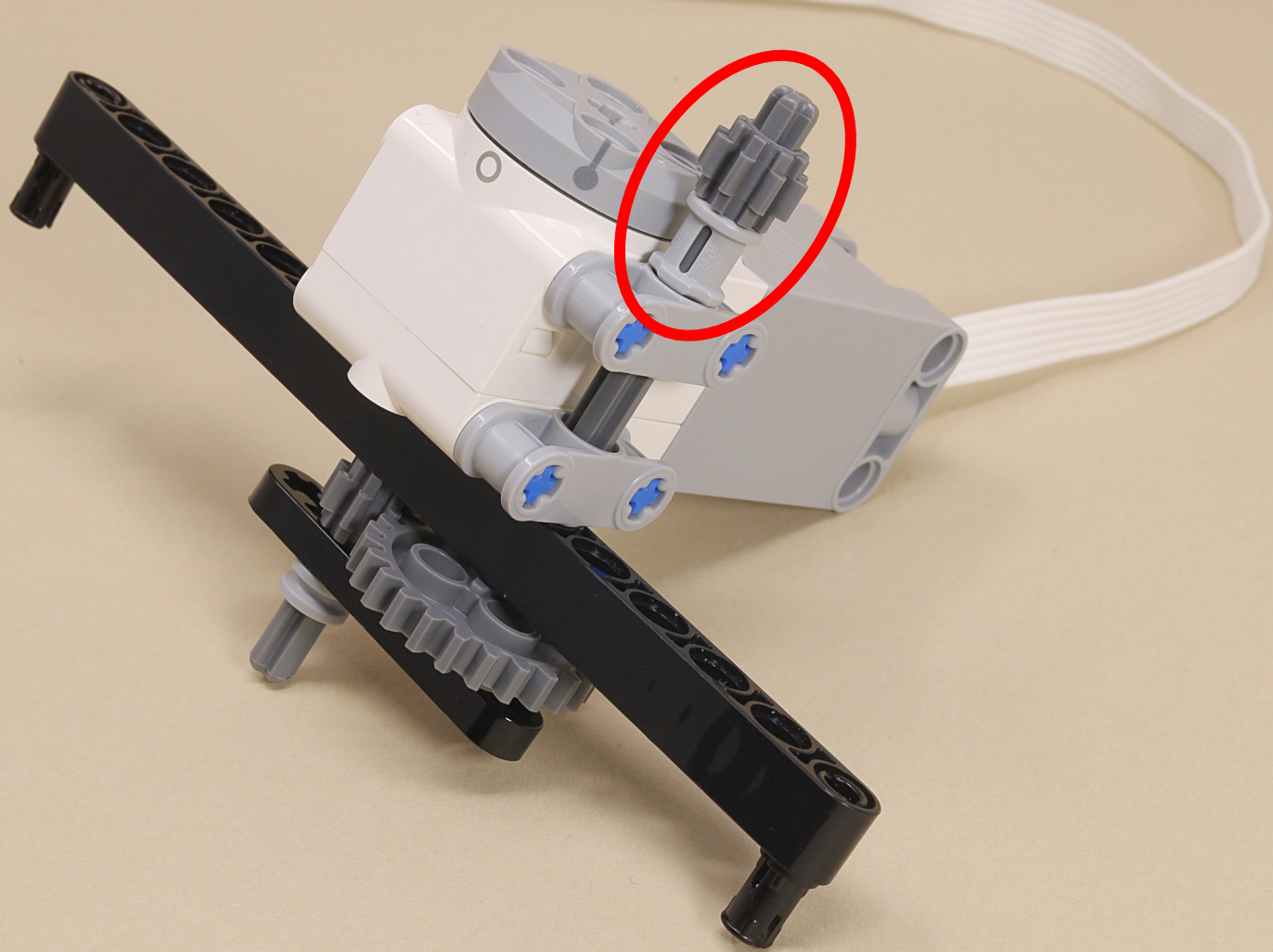

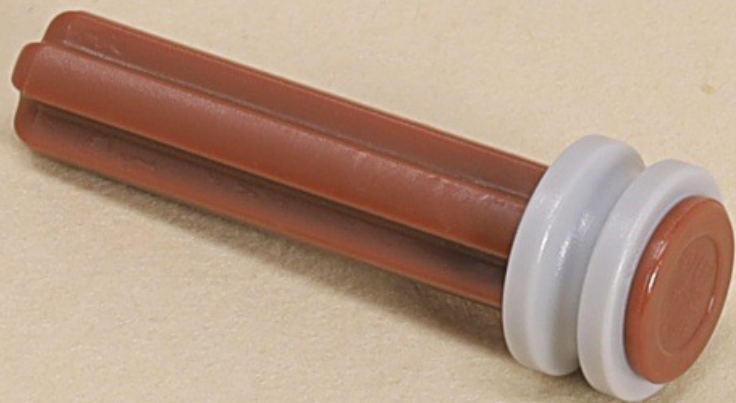

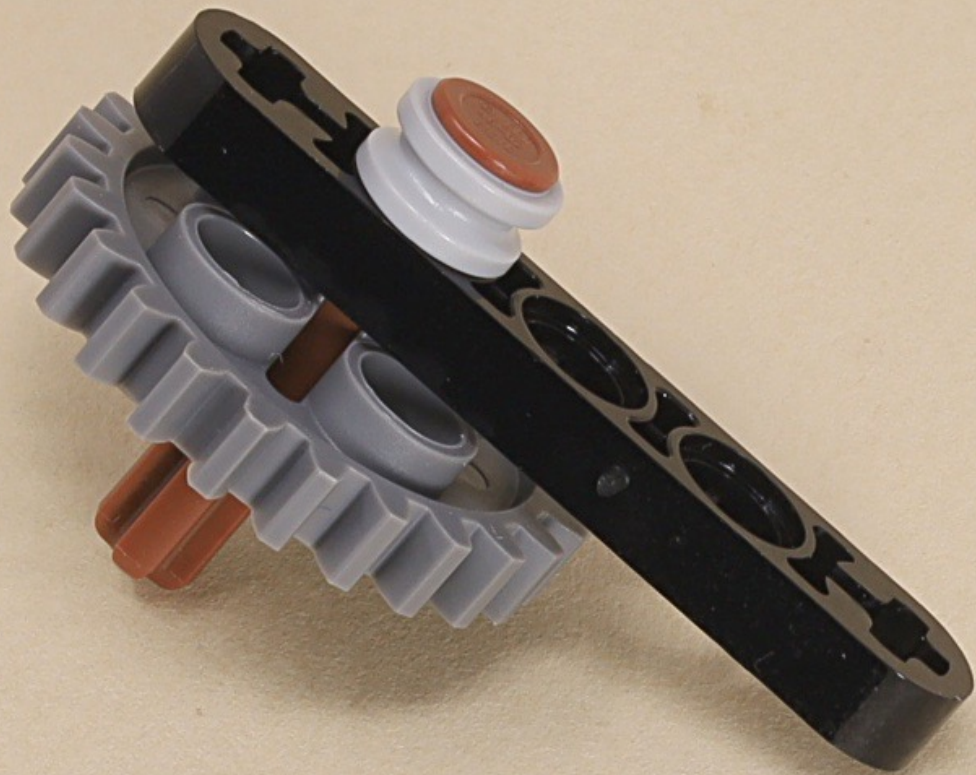

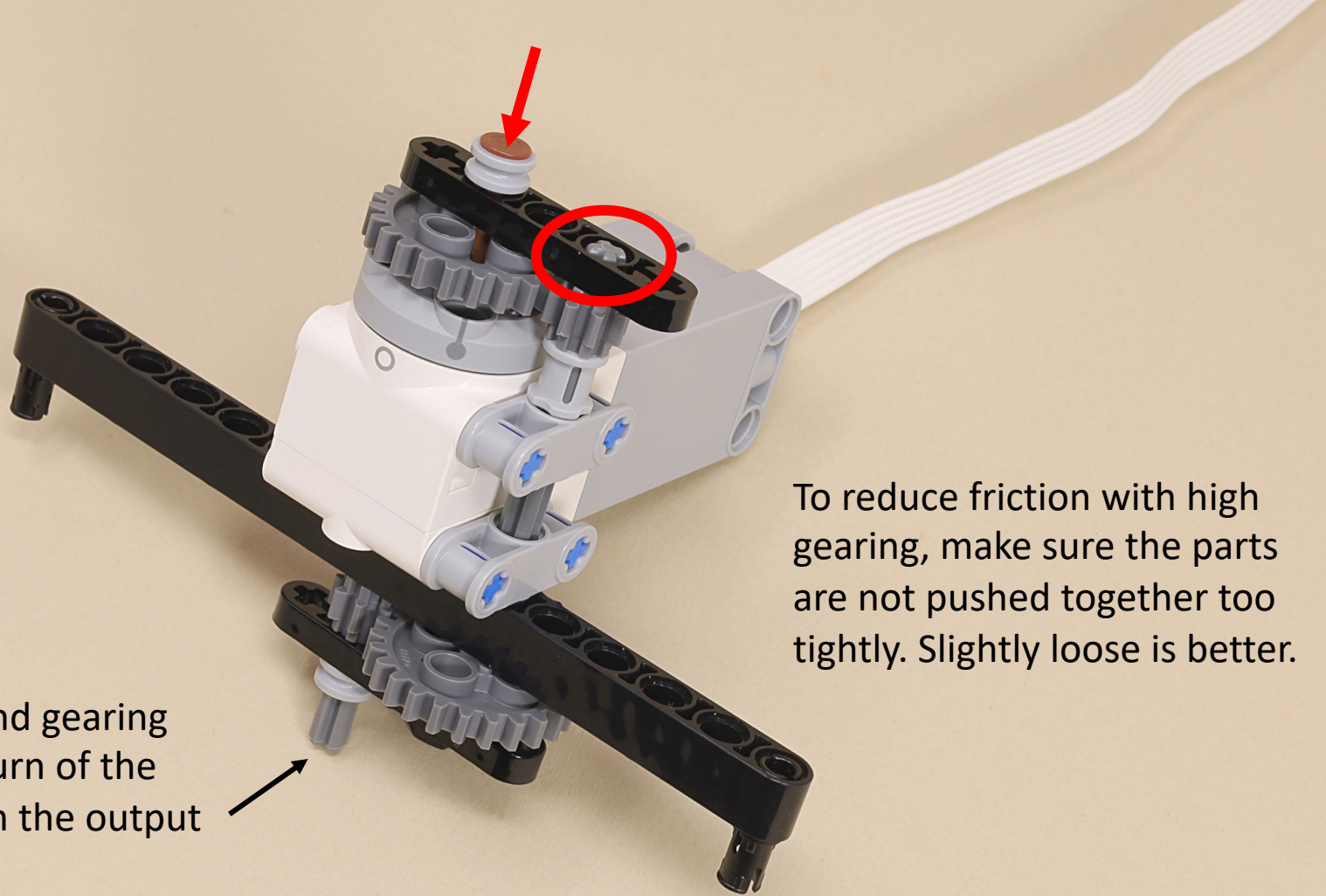

To reduce friction with high gearing, make sure the parts are not pushed together too tightly. Slightly loose is better.

The compound gearing causes one turn of the motor to turn the output axle 9 times.



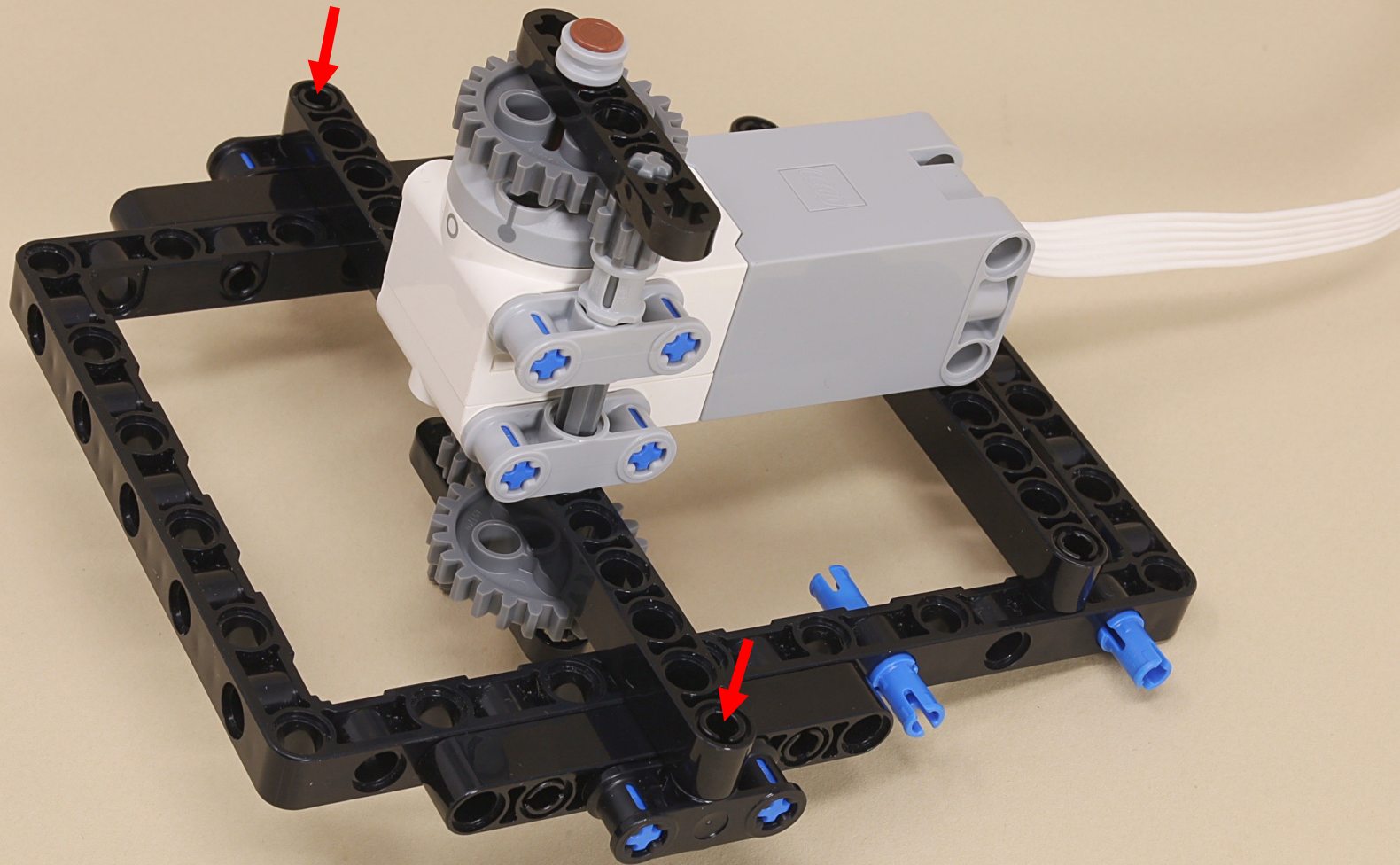



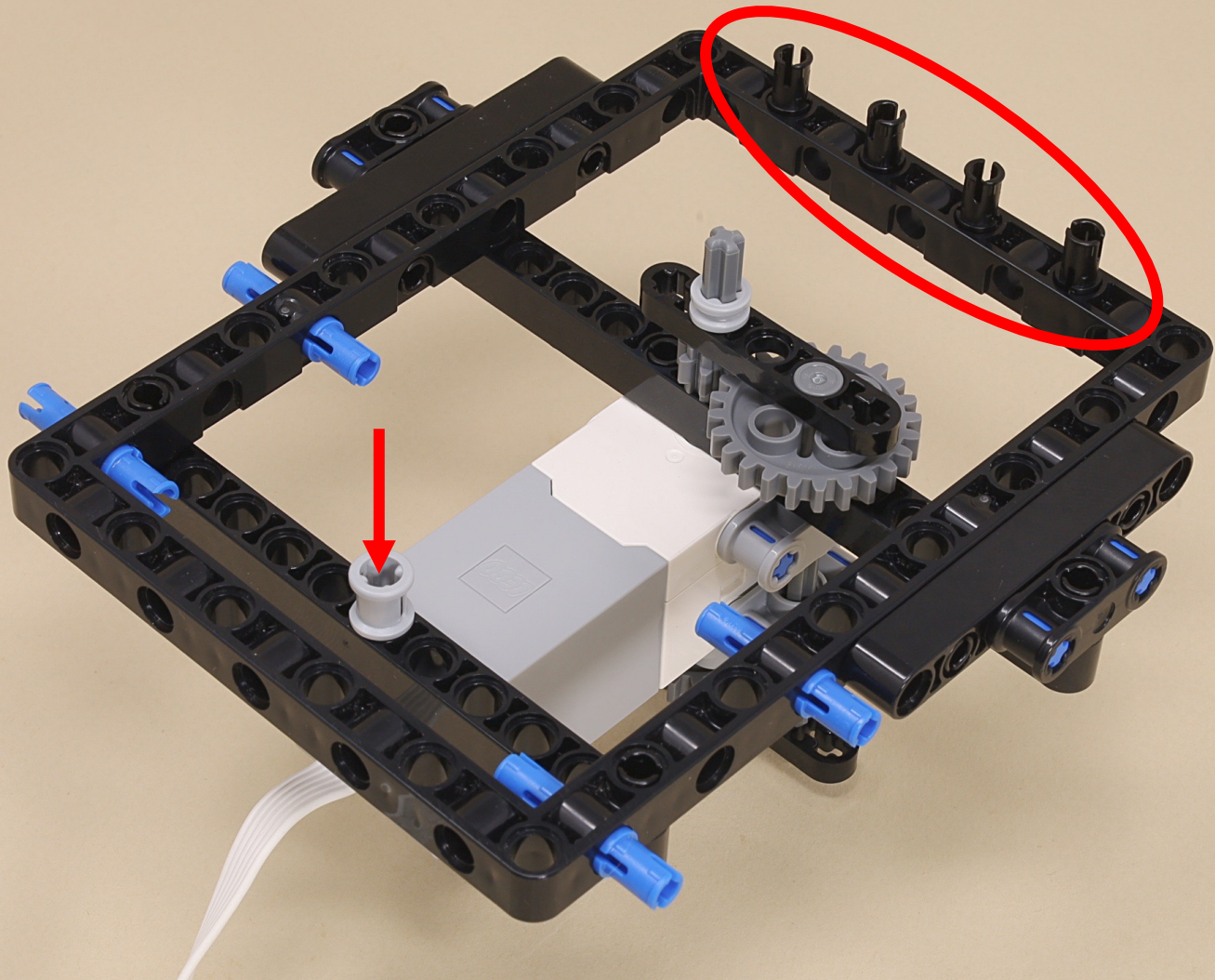

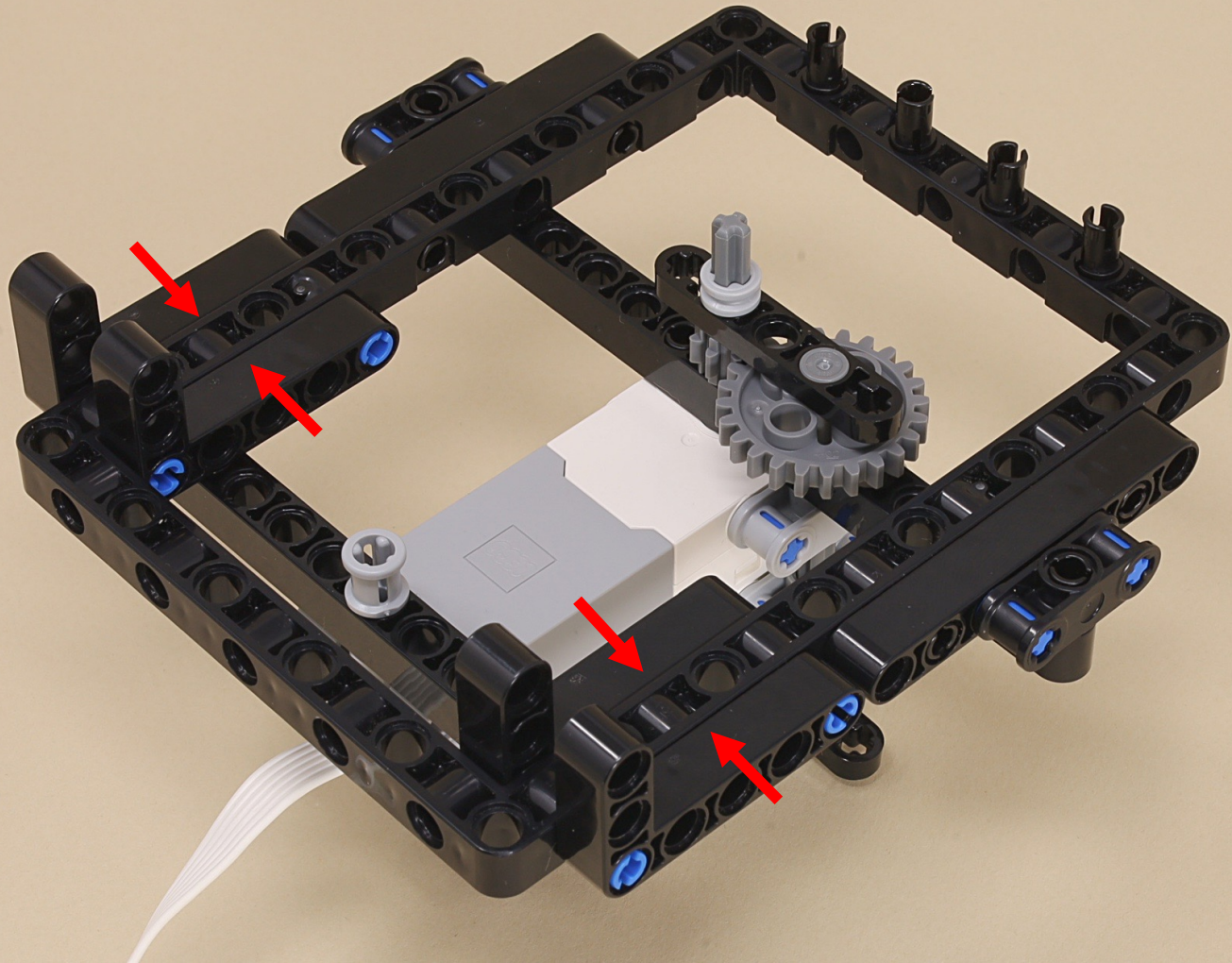

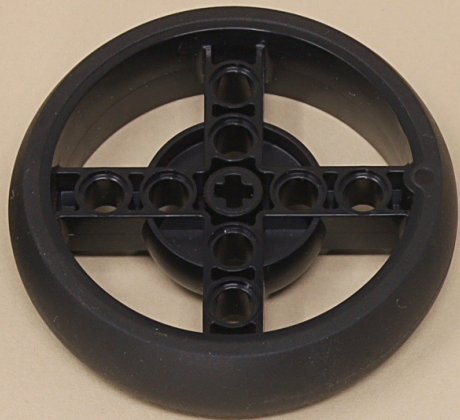

5



5



3



3





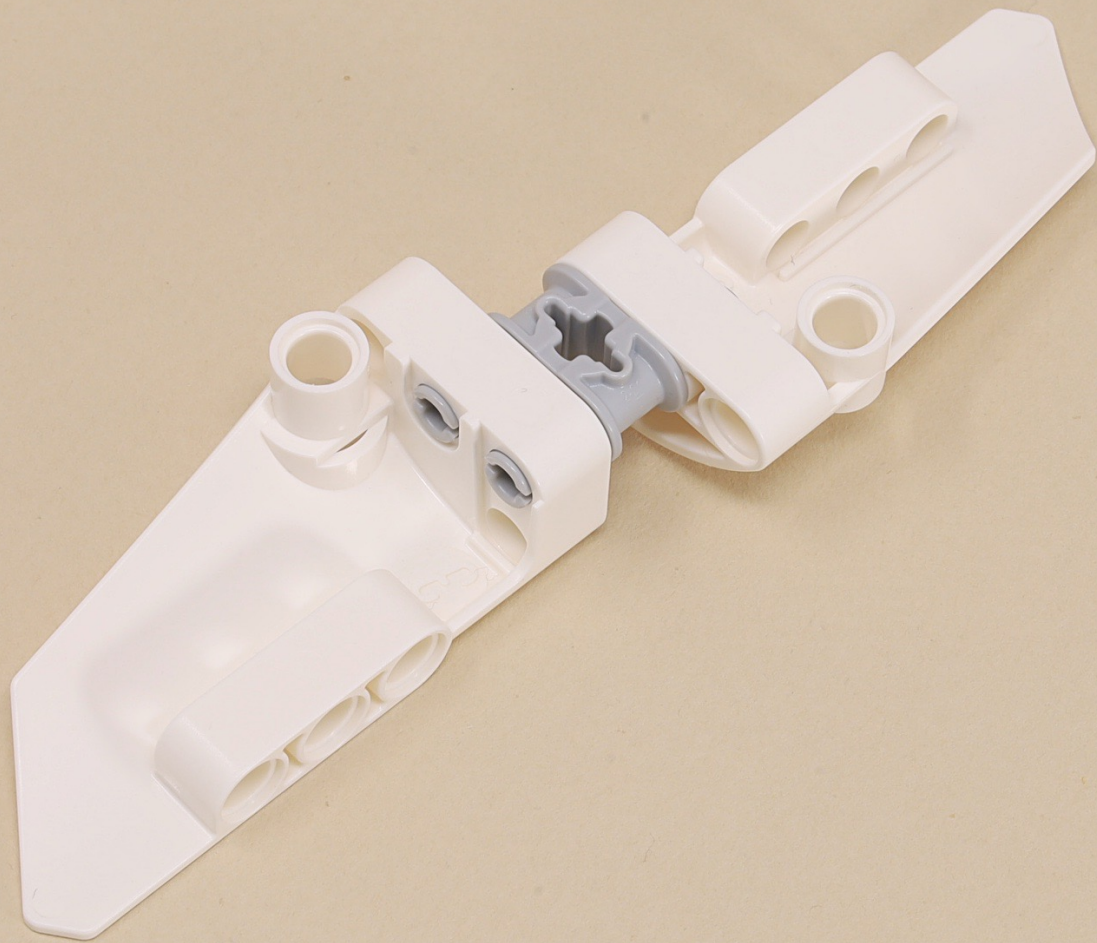

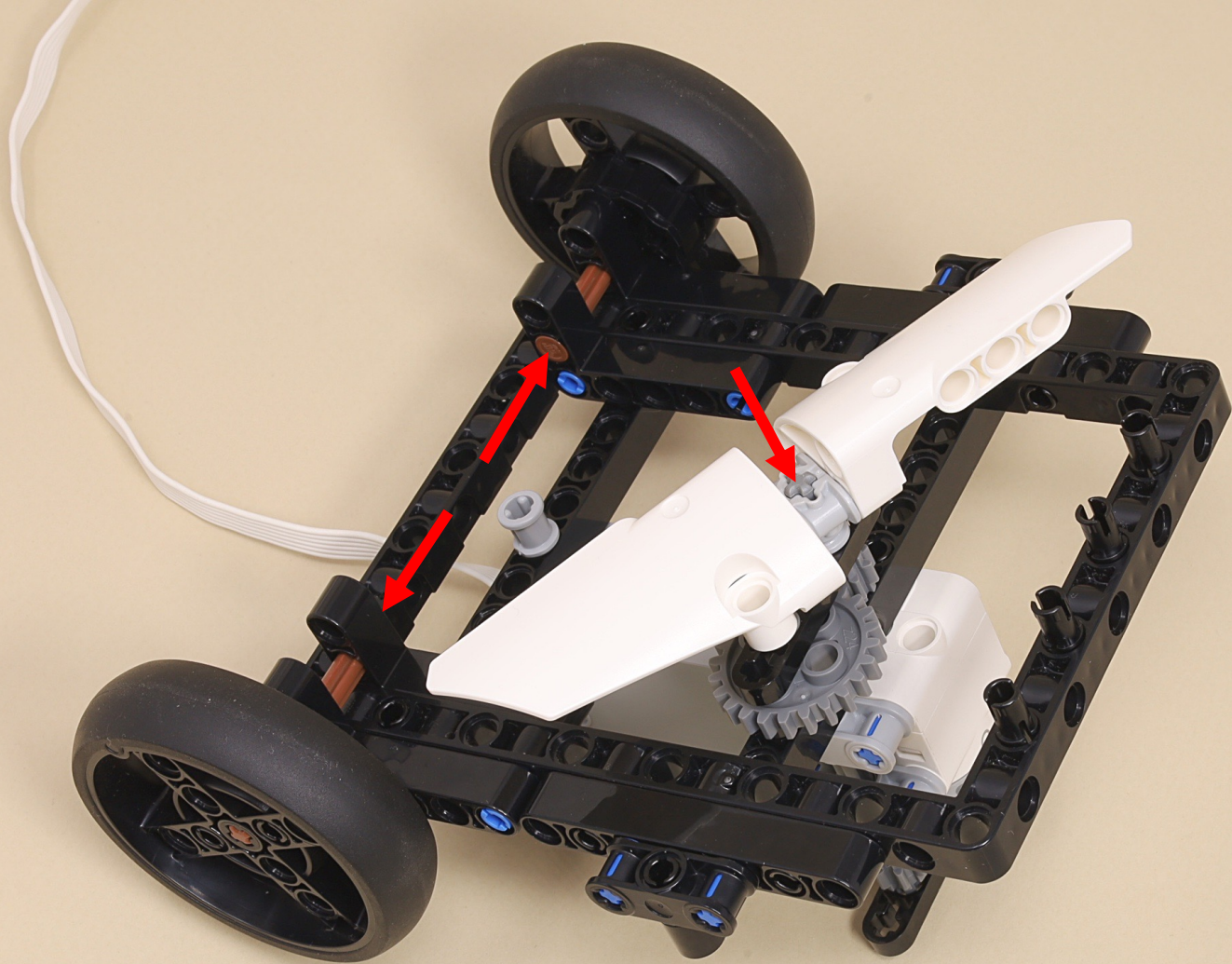



13



13



7



(8 x)



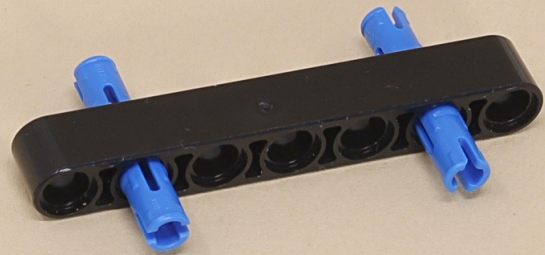
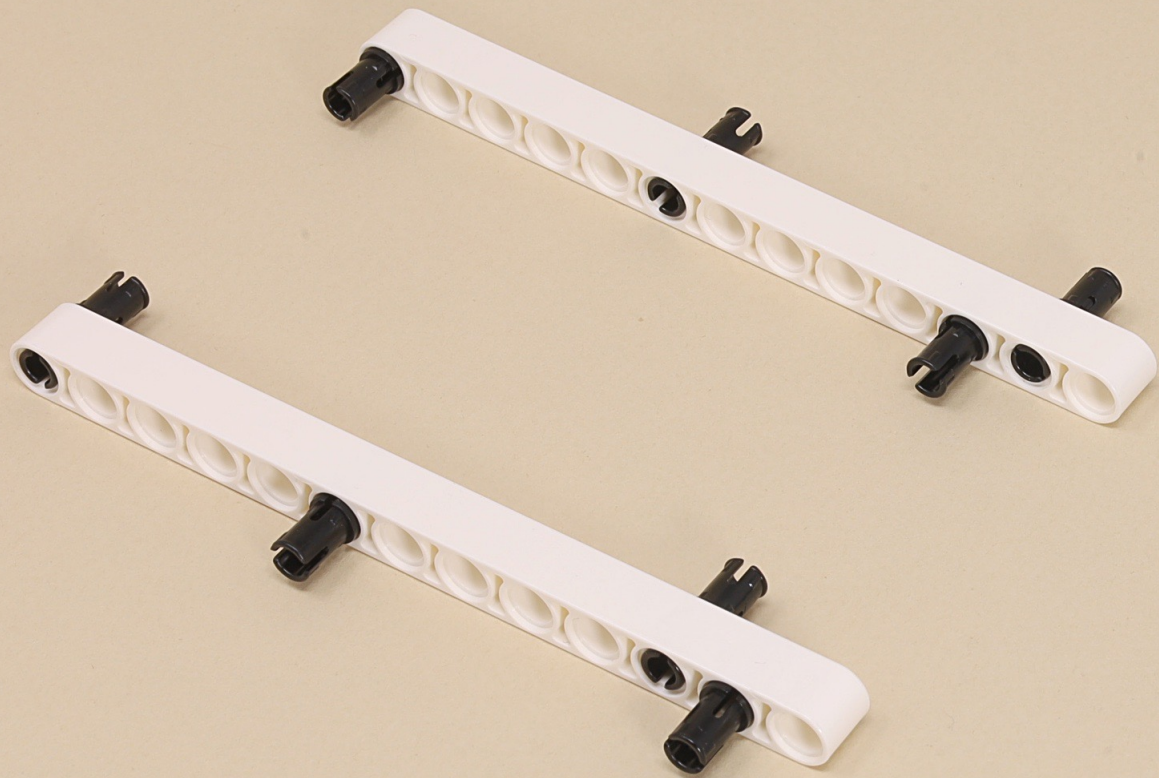





13



13



(14 x)

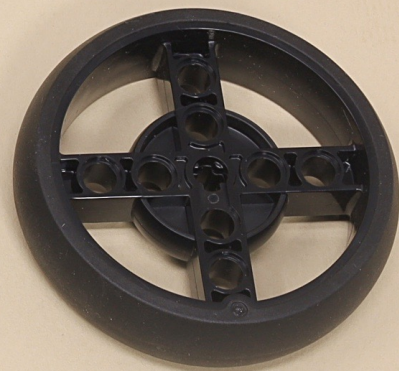
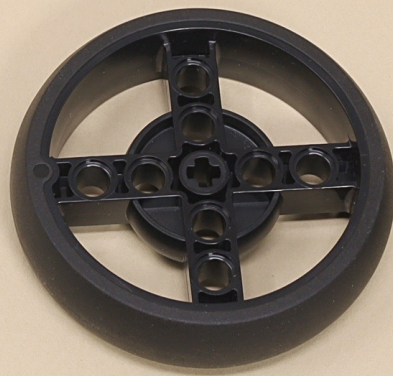

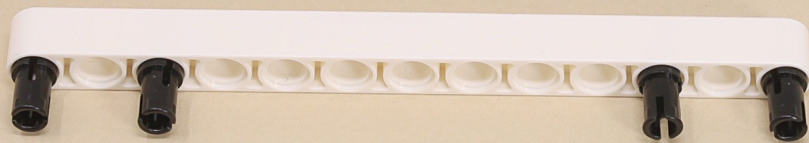
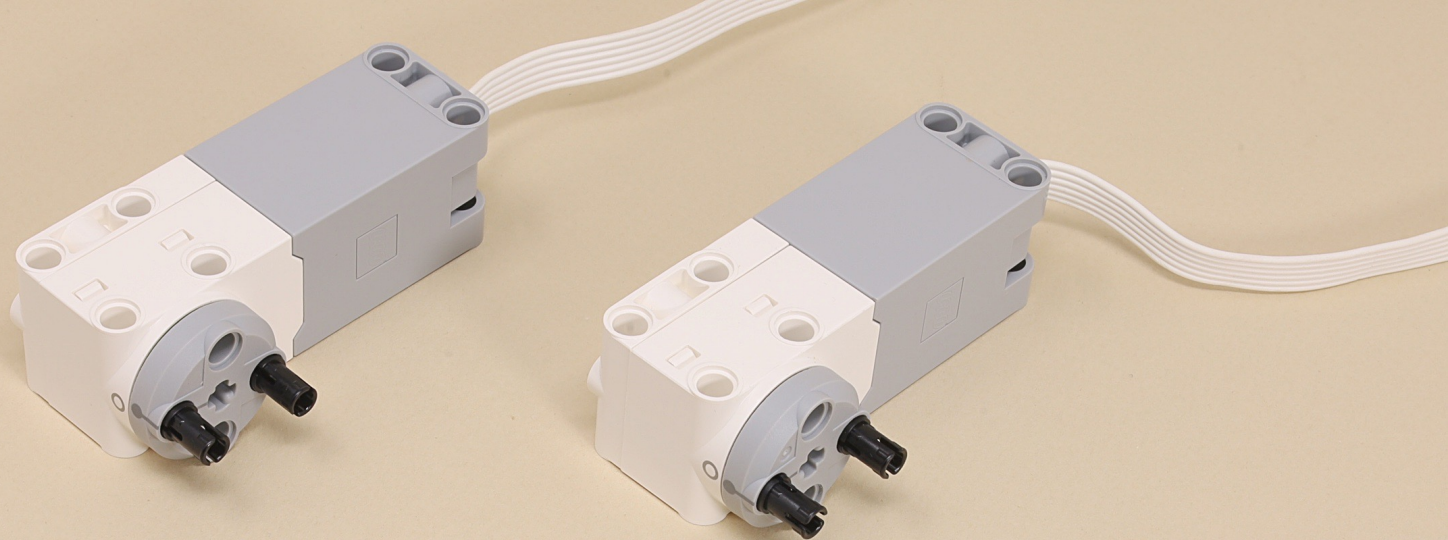

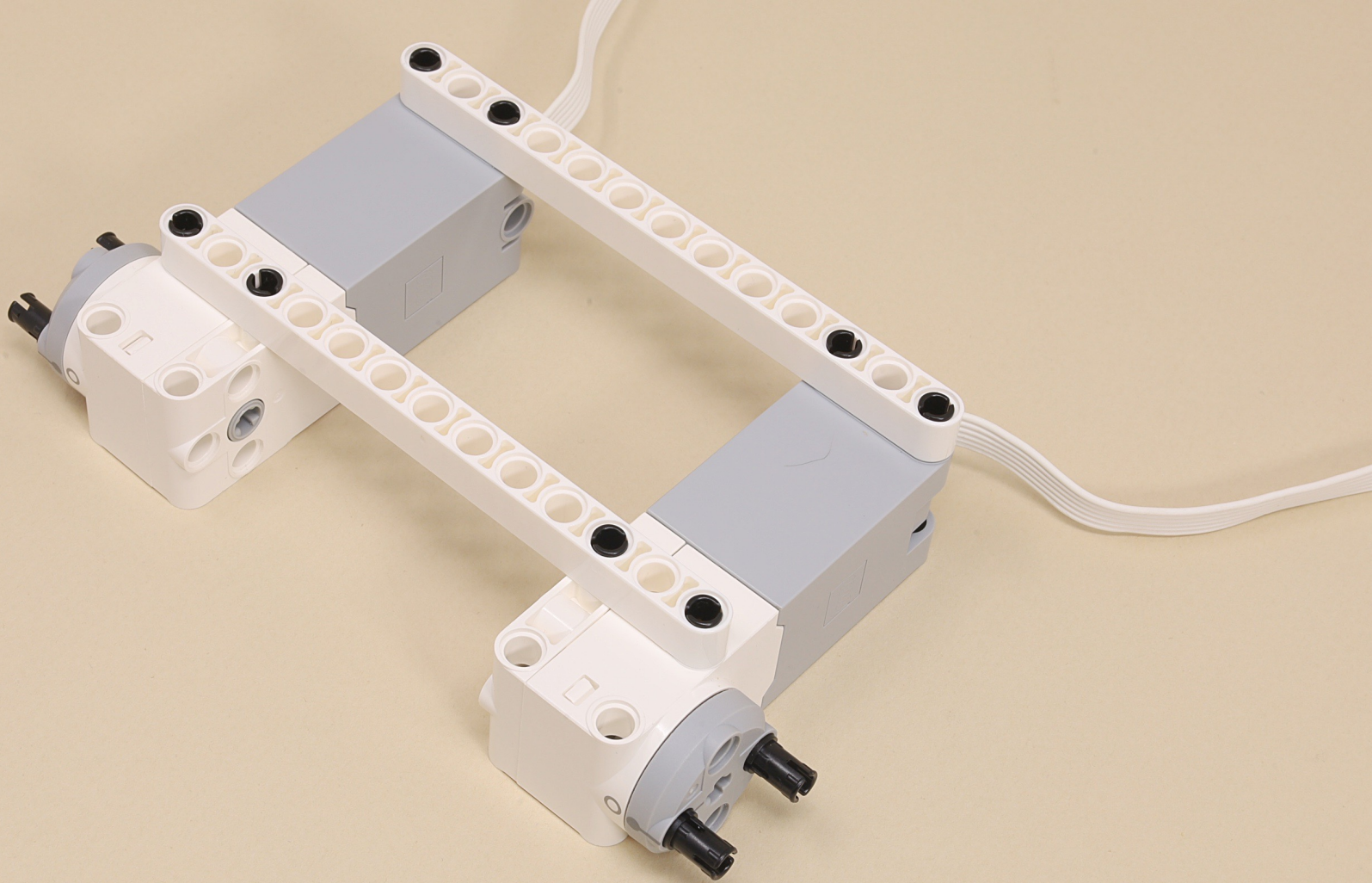

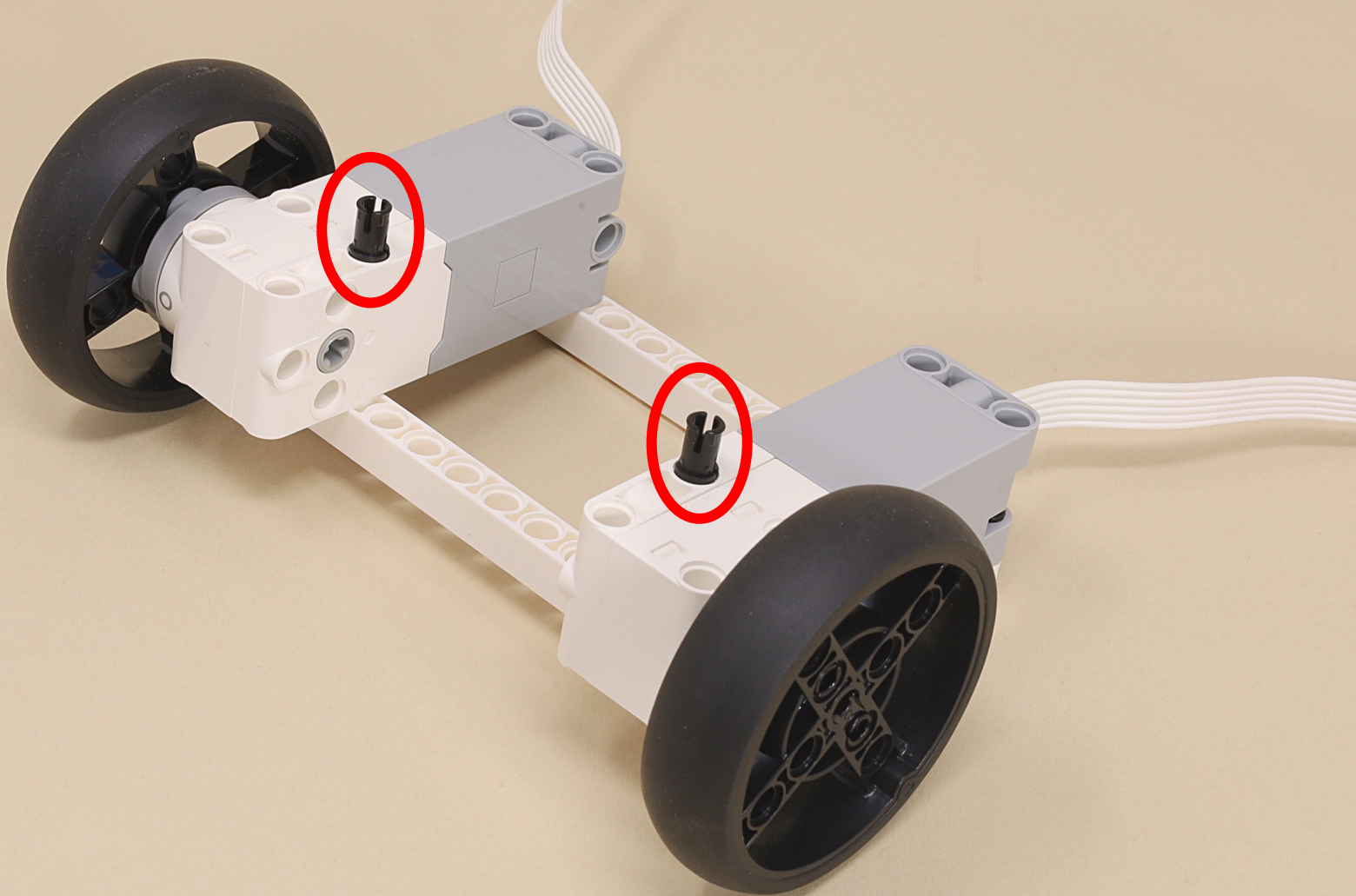

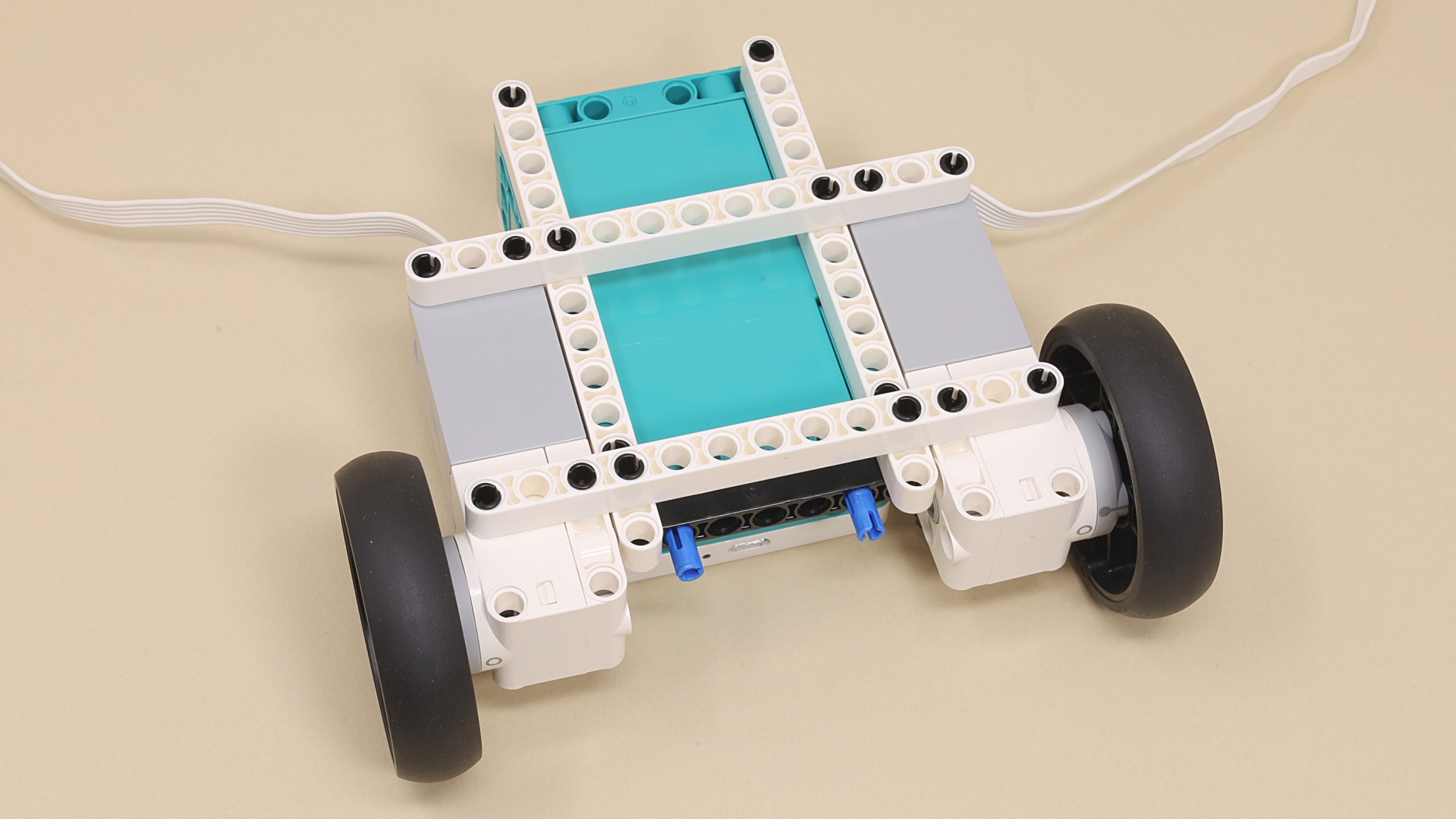

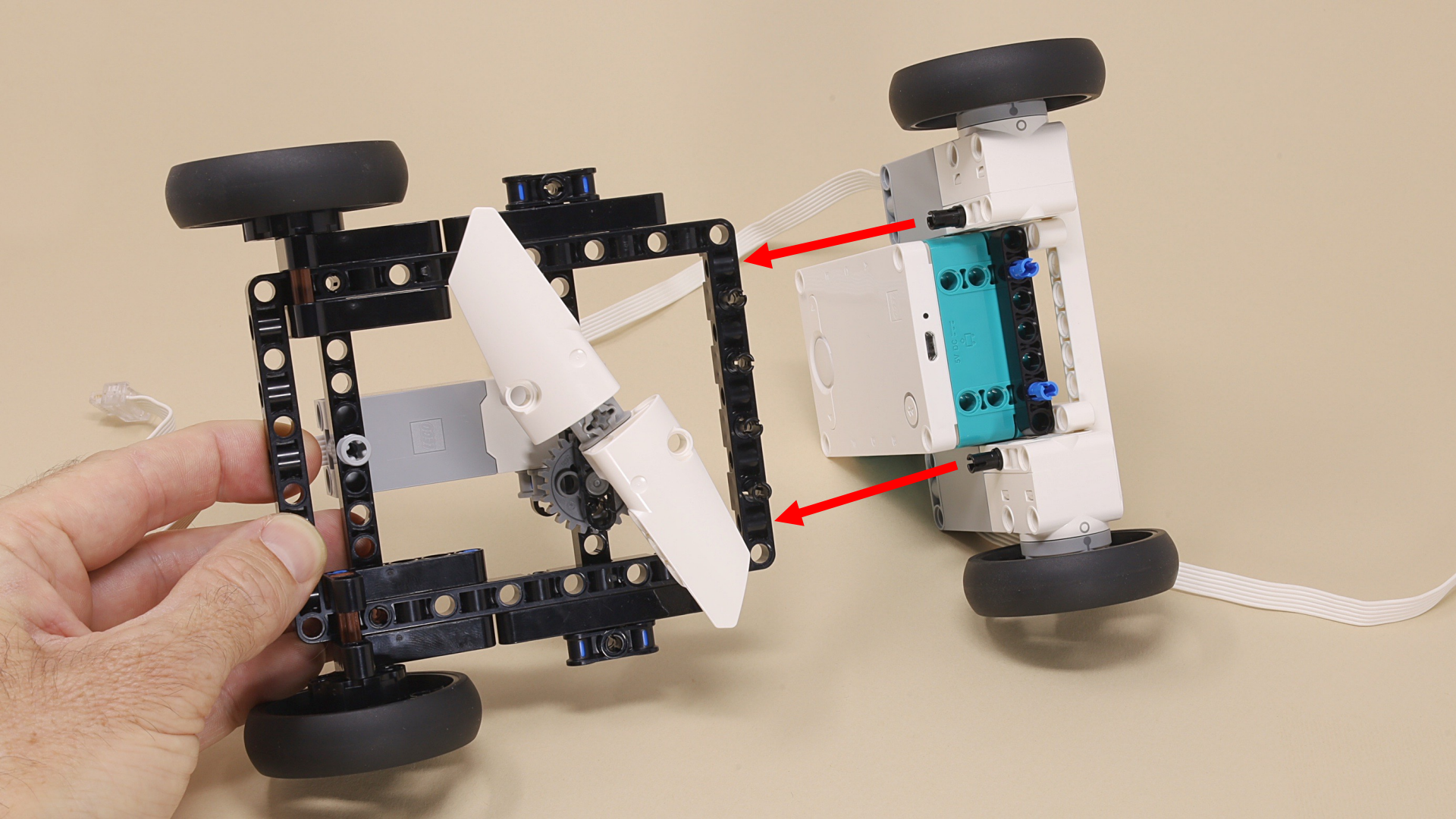

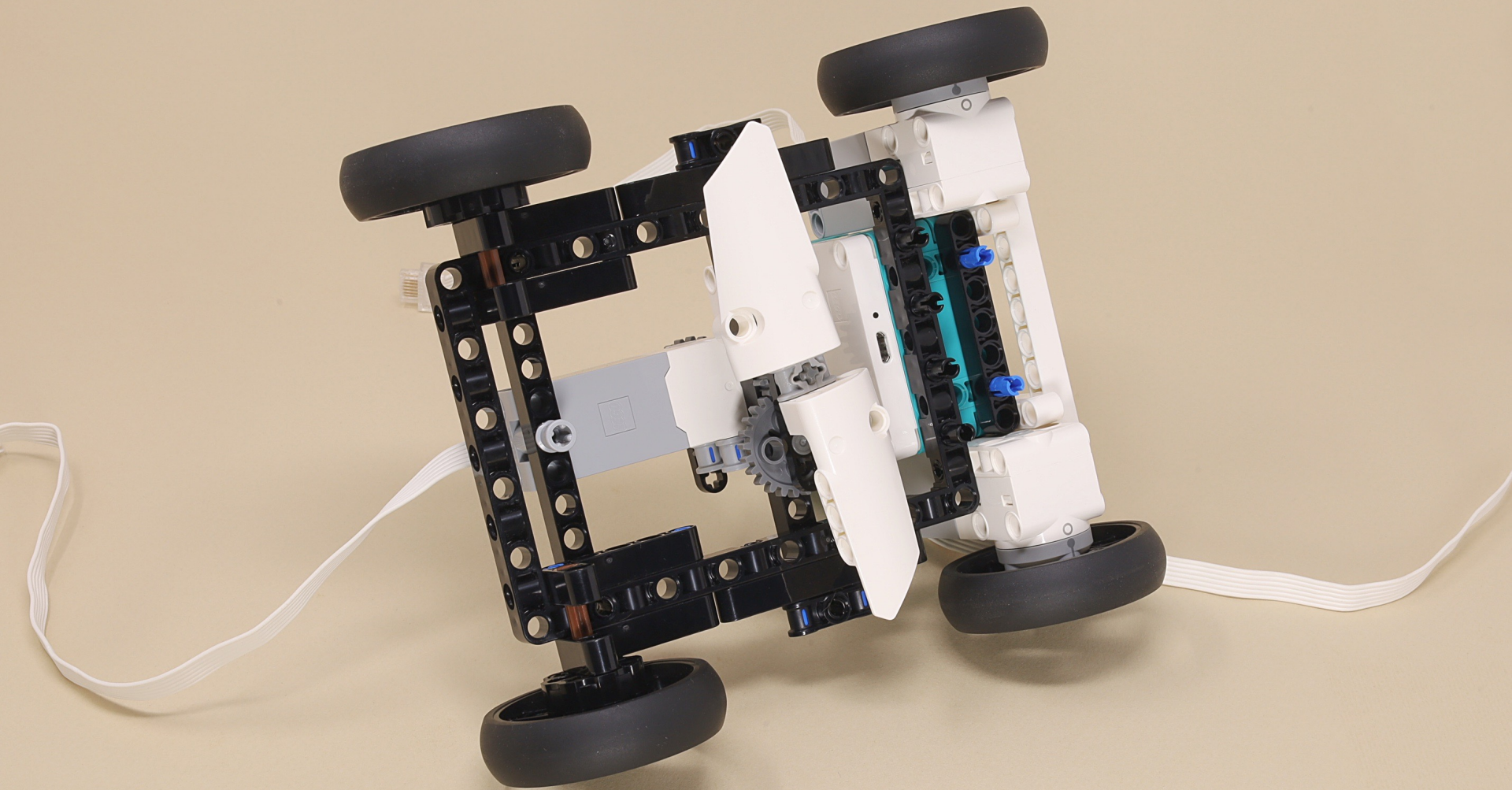



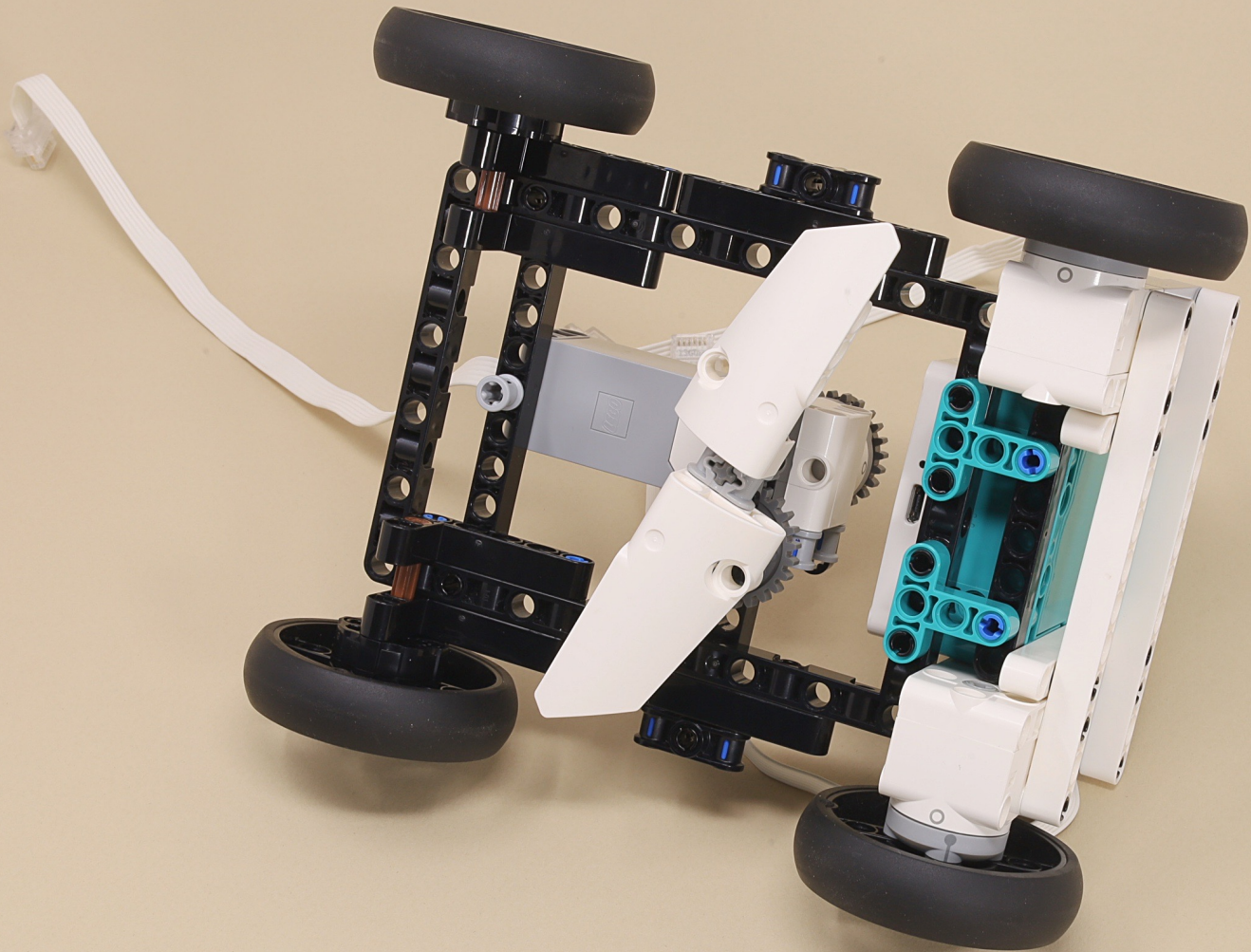





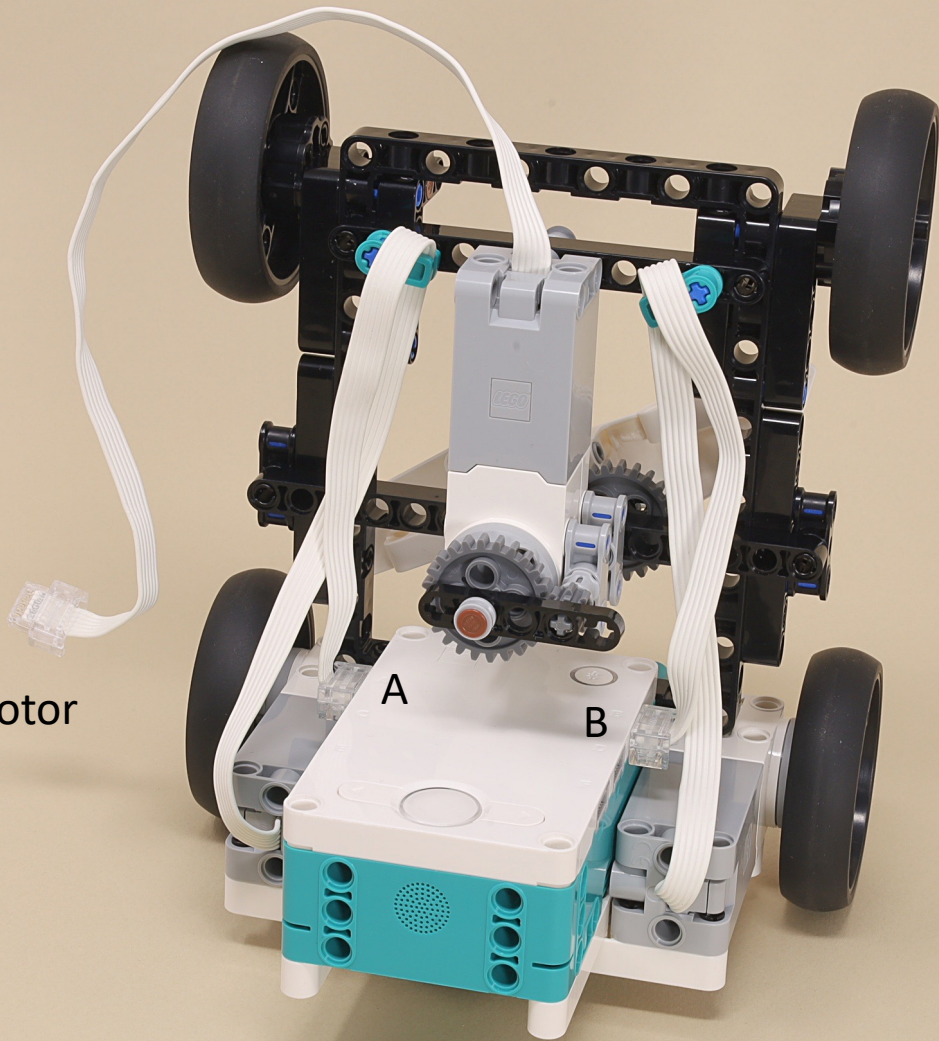

A = Left Drive Motor

B = Right Drive Motor

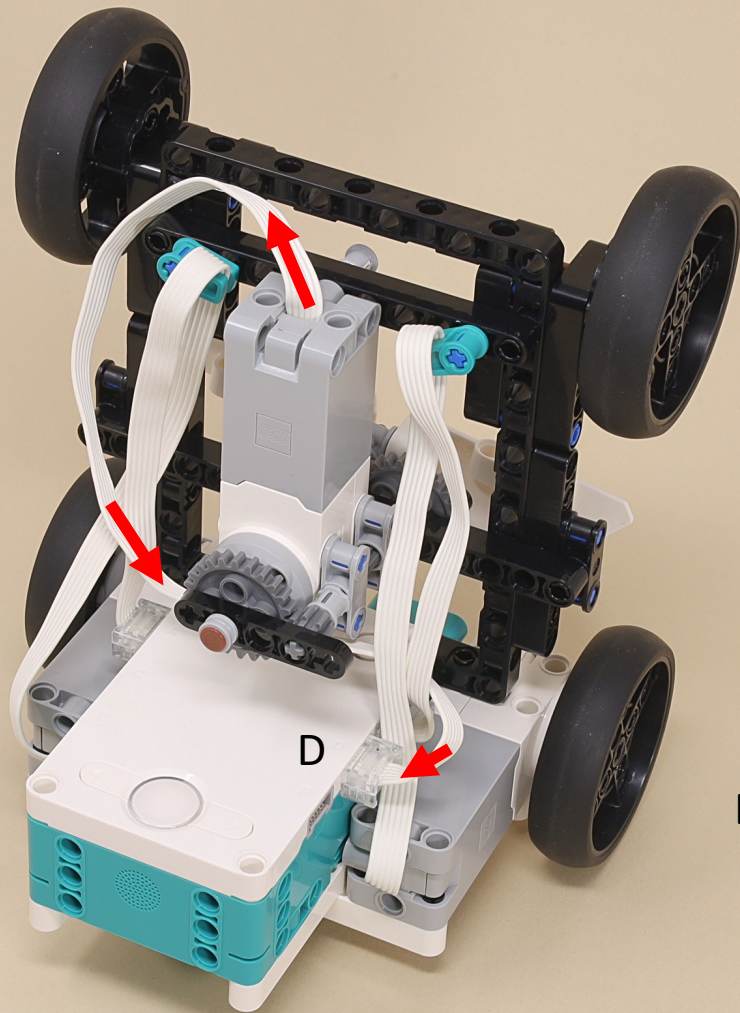

D = Blade Motor

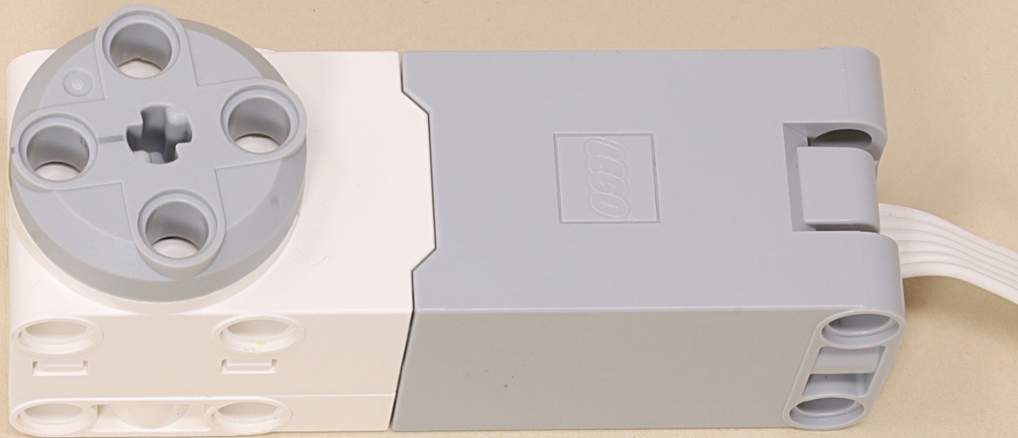
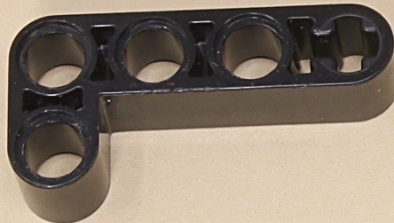
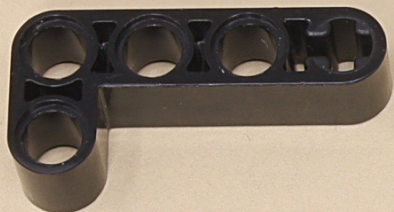



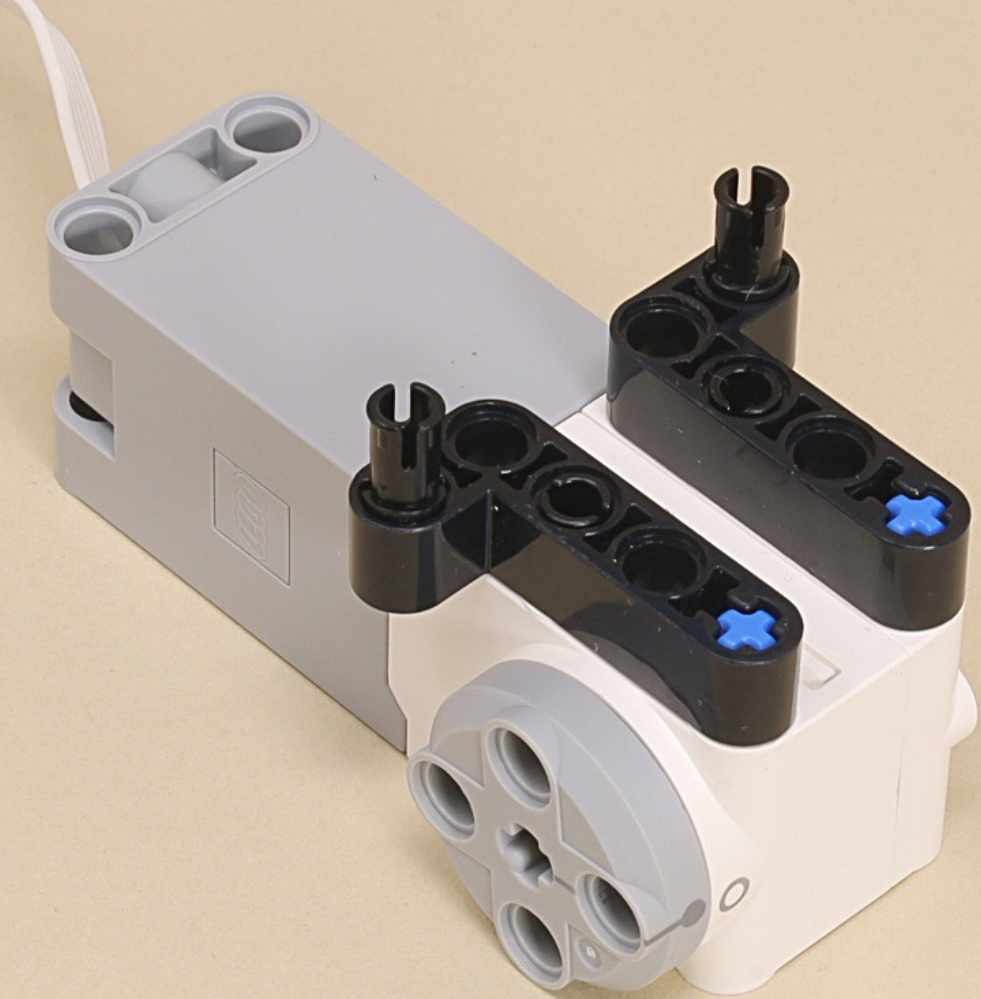

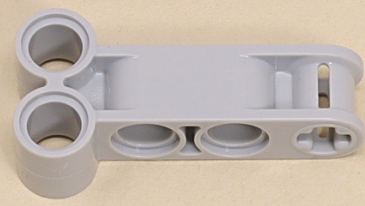
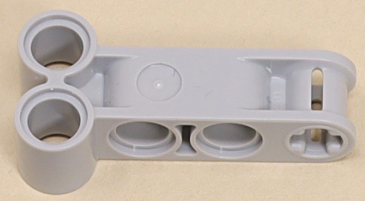

3

3

3



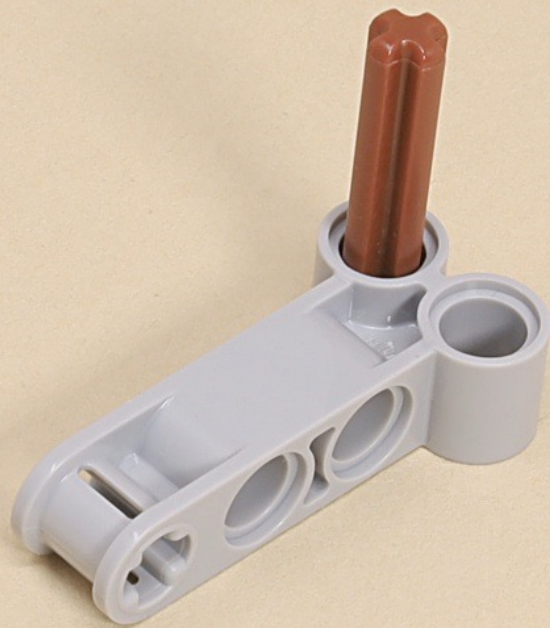





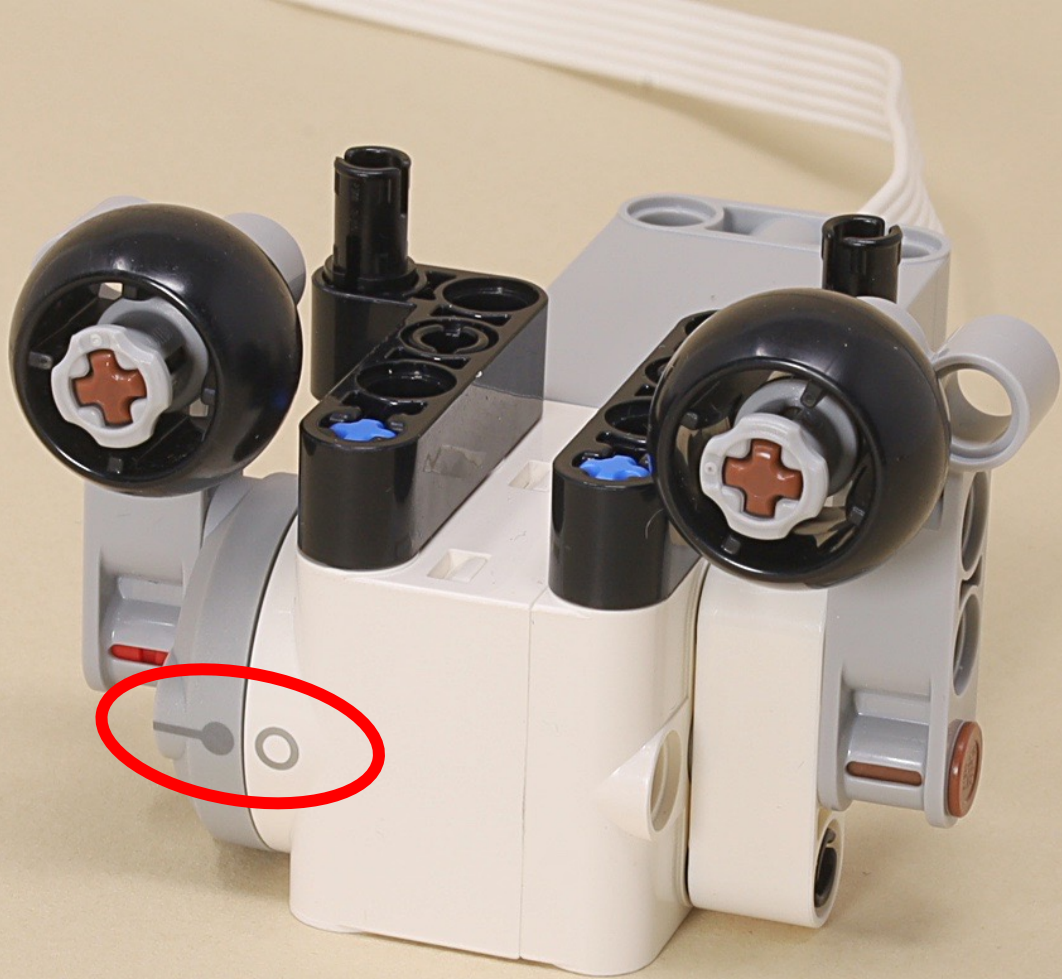

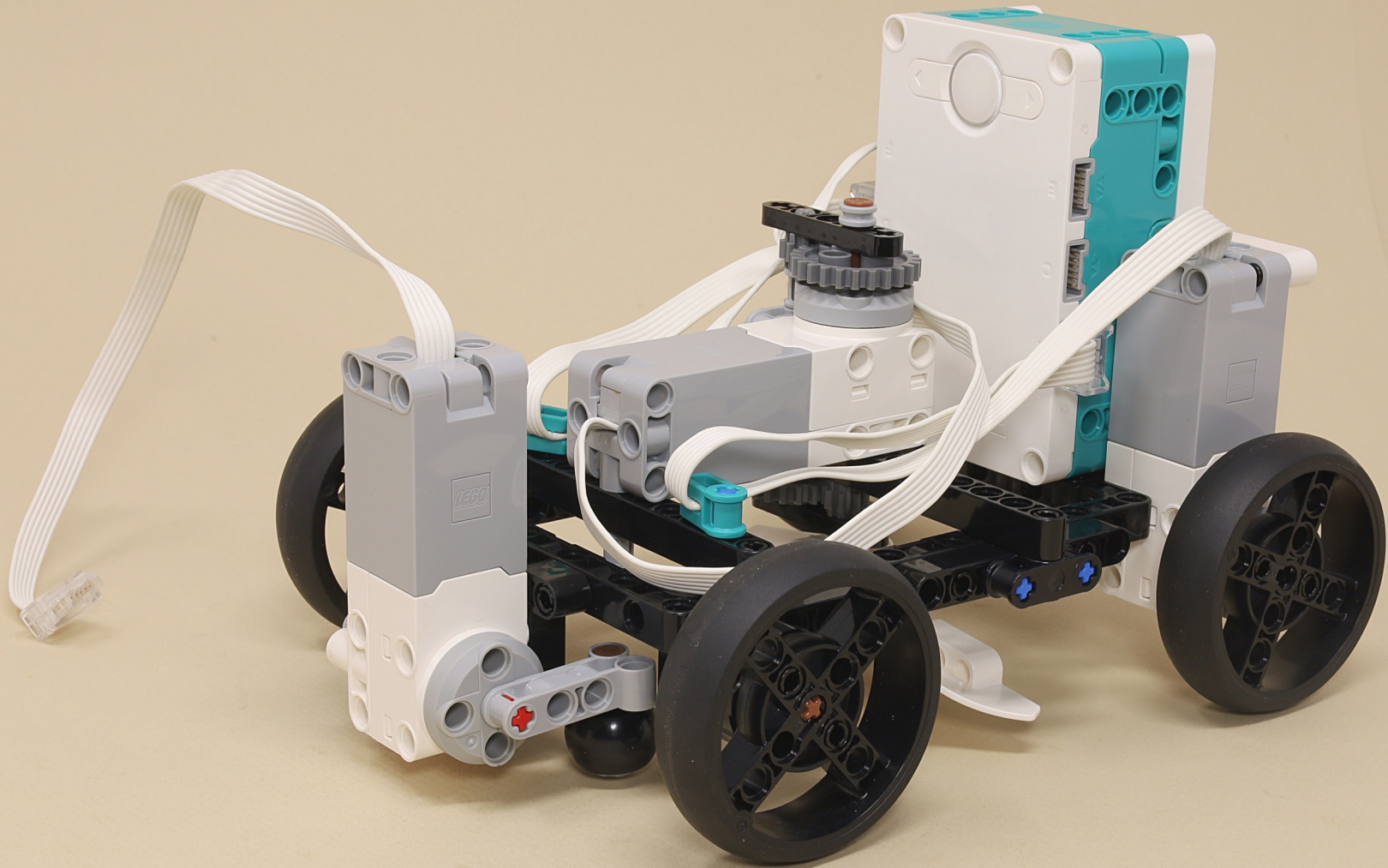

C = Lift Motor

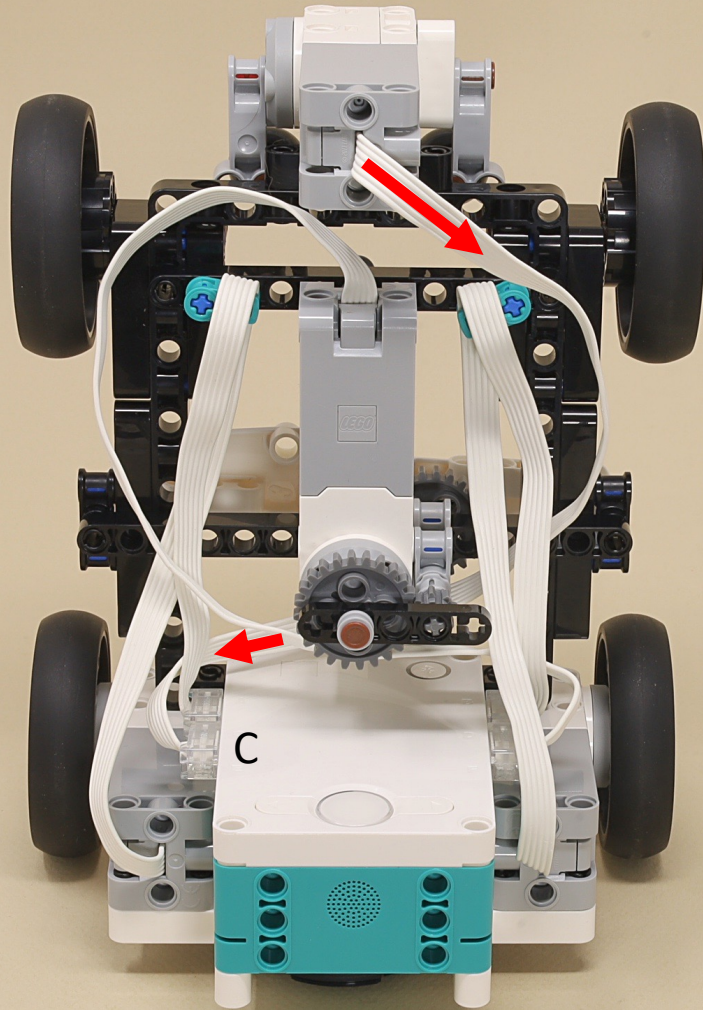

The lawnmower is functional at this point

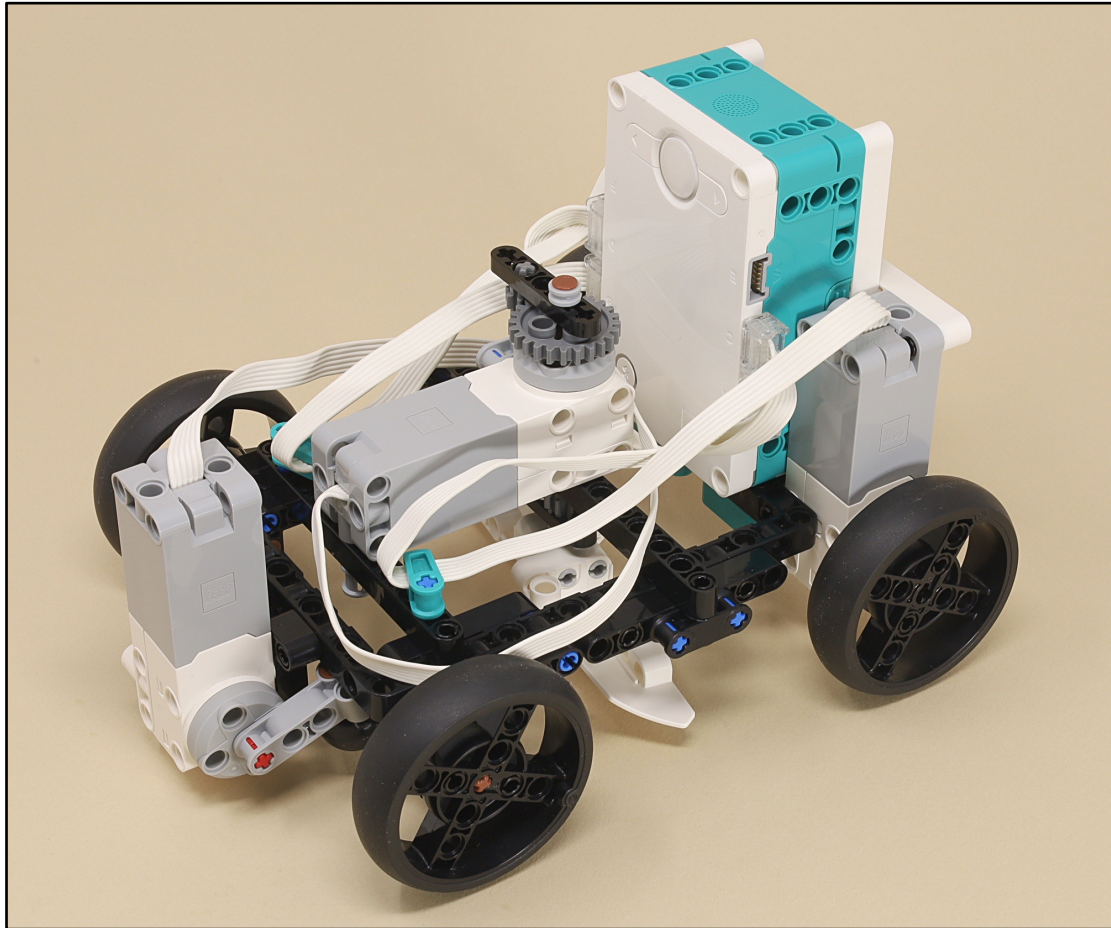

...but to finish it off, add:

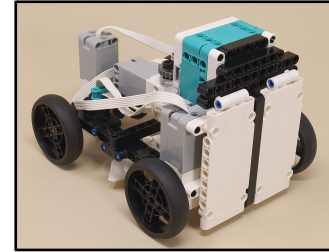

Rear Door



Handle

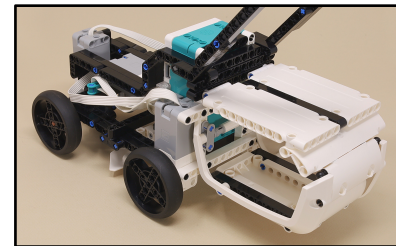

Bag